

Multi-Temperature-Controller KS 800

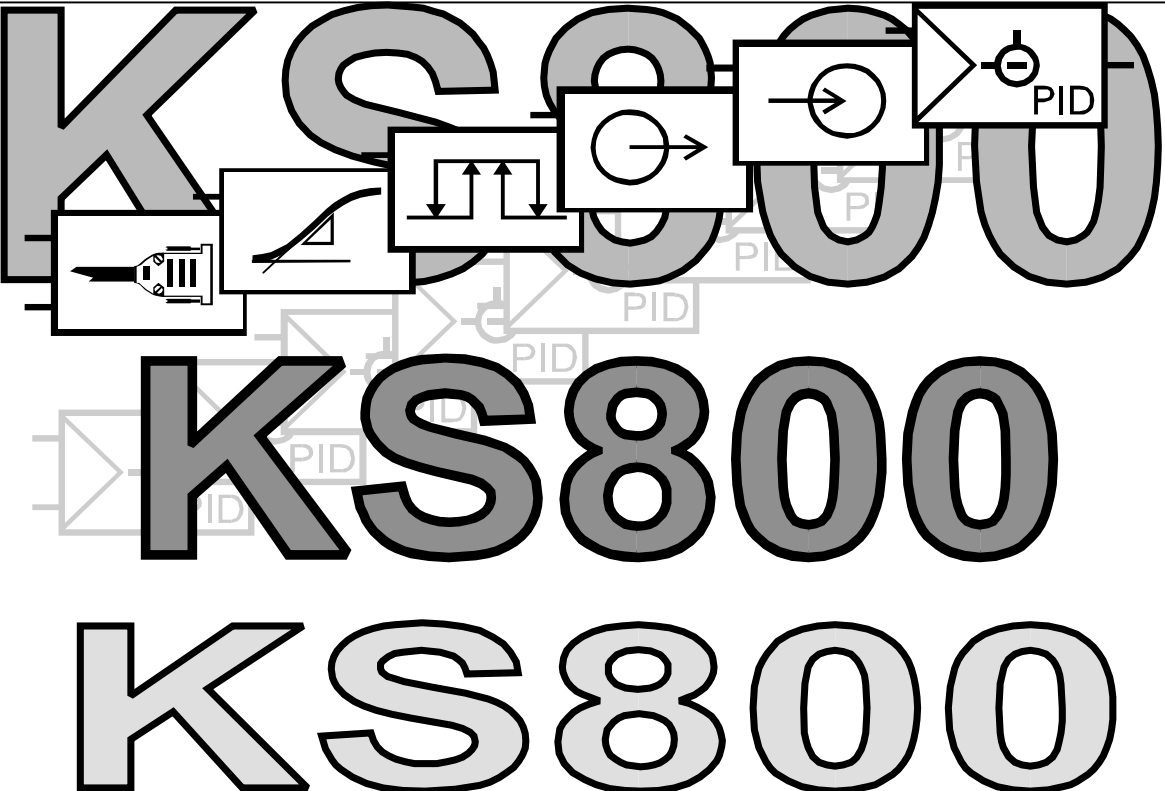

KS 800

KS 800

KS 800

KS

Functional Description

9499 040 49211

gültig ab 8393

©PMA Prozeß- und Maschinen-Automation GmbH. Printed in Germany
All rights reserved. No part of this document may be
reproduced or published in any form or by any means without prior written permission
by the copyright owner.

A publication of PMA Prozeß- und Maschinen-Automation GmbH

Subject to change without notice

PMA Prozeß- und Maschinen-Automation GmbH
P.O. Box 31 02 29
D 34058 Kassel
Germany

Restriction of warranty:

No warranty is given for the complete correctness of this manual, since errors can never avoided completely despite utmost care. Any hints are welcome and gratefully accepted.

Contents

1	Introduction	7
	1.1 Basic structure	7
	1.2 Input	7
	1.3 Functions	8
	1.4 Output	8
2	Input signal processing	9
	2.1 Measurement value pre-processing	9
	2.2 Measuring frequency	9
	2.3 Sensor types	9
	2.3.1 Thermocouples	9
	2.3.2 Resistance thermometer	10
	2.3.3 Resistance	10
	2.3.4 DC voltage	10
	2.4 Measurement value correction	11
	2.4.1 Application examples	12
	2.5 Digital input signal pre-processing	12
	2.5.1 Input signal distribution	12
	2.5.2 Analog input signals	12
	2.5.3 Digital input signals	13
3	Controller block diagram	14
	3.1 Sequence control	14
4	Set-point functions	15
	4.1 Set-point control	15
5	Function block protocol	16
	5.1 Data structure	16
	5.2 Structure of configuration words	17
	5.2.1 Function block instrument	17
6	Controller statuses and status priorities	21
	6.1 Priority 0 automatic	21
	6.2 Priority 1 Tune, run	21
	6.3 Priority 2 Tune, error	22
	6.4 Priority 3 Sensor break	22
	6.5 Priority 5 Manual	22
	6.6 Priority 7 Y_Track	23
	6.7 Priority 8 Controller off	23
7	Automatic - manual switch-over	24
8	Self-tuning for single-loop controllers	25
	8.1 Preparation for controller self-tuning:	25
	8.1.1 Process at rest	25
	8.1.2 Selecting the stable correcting variable	25
	8.1.3 Start from automatic mode	26
	8.1.4 Start from manual mode	26
	8.2 Self-tuning procedure with heating (2-point and three-point stepping controller)	26
	8.3 Self-tuning procedure with heating and cooling processes: (3-point controller)	26
	8.4 Set-point monitoring	27

8.5	Self-tuning several controllers in a group	27
8.5.1	Starting the group self-tuning	27
8.5.2	Group self-tuning stop	27
8.5.3	Common start of the heating attempt for all controllers of a group	27
8.5.4	Common start of the cooling attempt for all 3-point heating/cooling controllers	28
8.5.5	Signification of self-tuning messages	28
9	Controlled adaptation	29
9.1	Control function parameters	30
10	Signaller	31
11	Two-point controller	32
12	Three-point DPID controller	34
13	Three-point stepping controller	36
14	Forcing of switching outputs	39
15	Continuous controllers	40
16	Water cooling	42
16.1	Water cooling controller self-tuning	44
17	Cascade control	45
17.1	Configuration of a simple cascade	45
17.2	Controller behaviour with switch-over	46
17.2.1	Master controller switch-over from	46
17.2.2	Slave controller switch-over :	46
17.3	Interruption of cascade operation	46
17.4	Example of cascade control with up to 7 slave controllers	47
18	Start-up circuit	49
19	Mean value formation for the output hold function	51
20	Heating current monitoring	52
20.1	Heating current monitoring	52
20.2	Monitoring cycle	52
20.2.1	Heating current alarm, reset and quick test	53
21	Evaluation of heating current measurement	54
21.1	Leakage current monitoring	54
21.2	Heating current scaling factor	55
22	Alarm handling	56
23	Configuration	58
23.1	General	58
23.2	Main configuration groups	58
23.2.1	C100 main controller configuration	58
23.2.1.1	C101 additional controller configuration	59
23.2.2	Control loop monitoring (loop alarm)	60
23.2.3	C150 Heating current and output monitoring	61
23.2.3.1	C151 additional heating current configuration	62

23.2.4	C180 analog signal allocation	62
23.2.5	C190 digital signal allocation	63
23.3	Inputs	64
23.3.1	C200 main configuration	64
23.3.2	Input scaling	65
23.3.2.1	C201 input scaling start	65
23.3.2.2	C202 input scaling end	65
23.3.3	C205 additional configuration	66
23.3.3.1	C210 external temperature compensation	66
23.3.3.2	C213 sensor failure	67
23.3.3.3	C214 filter time constant	67
23.4	Configuration examples	68
23.4.1	Thermocouples	68
23.4.2	Resistance thermometer	68
23.4.3	Voltage	68
23.4.4	C302 heating current input	68
23.5	Outputs	69
23.5.1	C500 signal inputs/outputs	69
23.5.2	Alarm outputs	70
23.5.2.1	Action C530	70
23.5.3	Analog outputs	71
23.5.3.1	C600, C602, C603, C604 type of alarms	72
23.5.3.2	C601 alarm target	73
23.5.4	C700 controller self-tuning	74
23.5.5	Additional functions	75
23.5.5.1	C900 Baud rate COM1 PC interface	75
23.5.5.2	C901 COM1 address	75
23.5.6	COM2 interface	76
23.5.6.1	C902 Baud rate COM2 bus interface	77
23.5.6.2	C903 COM2 address	77
23.5.7	C904 mains frequency, alarm and current output configuration	78
24	Special functions	79
24.1	Selective mean value formation	79
24.1.1	Configuration	81
24.2	Safety limiter with holding function	82

1 Introduction

The functions of multiple controller KS 800 are described in this document. Not all functions are applicable to all versions, since some hardware and software functions are mutually precluding due to the controller configuration (e.g. 8-channel three-point stepping controller and digital inputs).

1.1 Basic structure

The basic KS 800 structure for control function handling is shown below. The unit is divided into four main groups:

- input
- functions
- output
- user interface

(The user interface function is not described in this manual.)

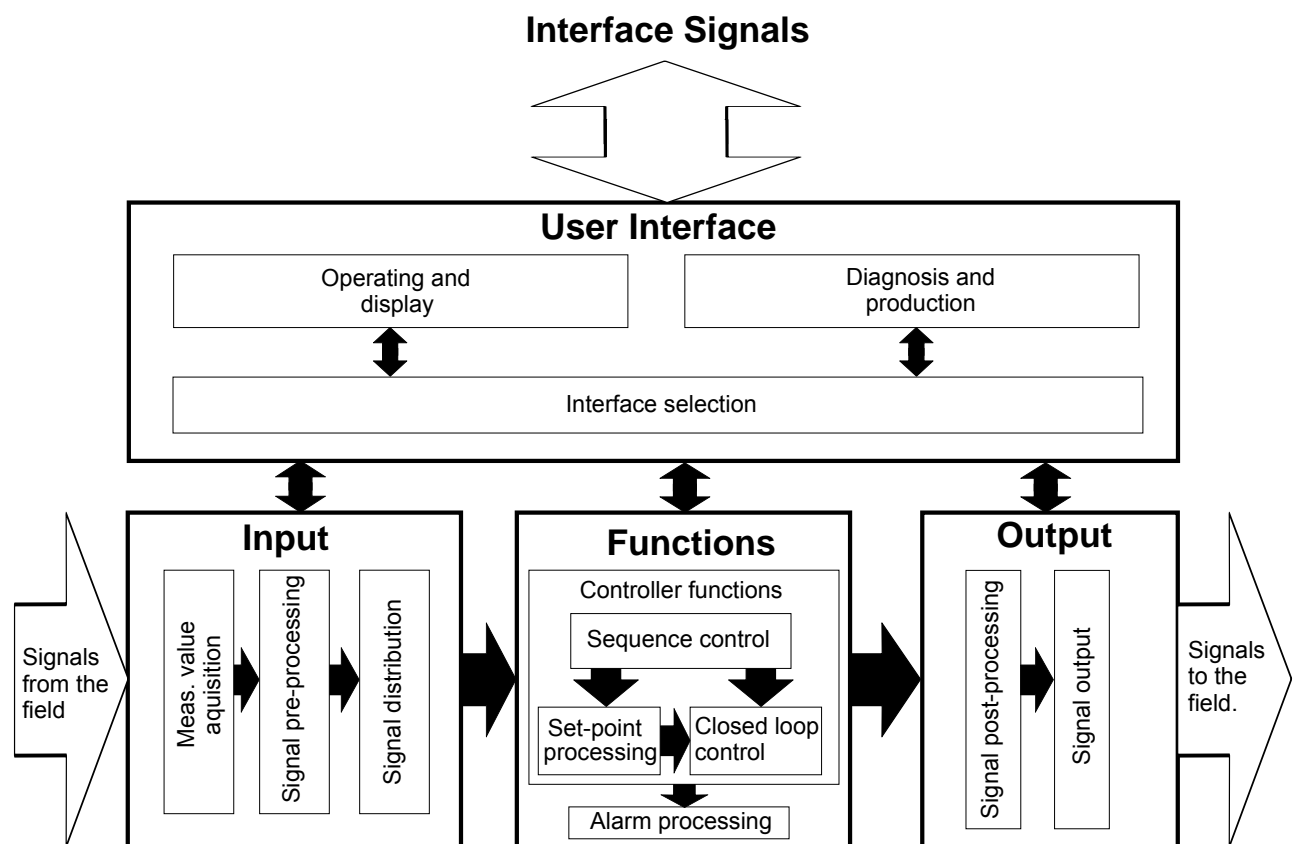

1.2 Input

Measurement value acquisition

The input signals from the field are acquisitioned and converted according to adjusted sensor type.

Measurement value correction

This block is used for measurement value corrections (zero offset, suppression, gain adjustment).

Signal distribution

The conditioned input signals are passed to the controller cyclically (together with the relevant control parameters).

1.3 Functions

Sequence control

The sequence control describes the statuses and priorities in the control algorithm and the conditions and signals for other function statuses.

Closed-loop control

The correcting variable is calculated dependent of selected controller configuration and adjusted control parameters.

Set-point processing

Dependent of controller configuration, various functions for generation of the valid (effective) set-point (Weff) are selected for the control functions.

Alarm processing

Each individual controller has different alarm functions, each with four trigger points. The alarms can be allocated to various alarm functions by configuration.

1.4 Output

Signal post-processing

The controller calculation result is subject to (user-defined) post-processing: e.g. compliance with a minimum duty cycle.

Signal output

Output and storage of the controller output value until the next cycle.

2 Input signal processing

2.1 Measurement value pre-processing

All measurement signals must be conditioned accordingly, before they are used in the controller functions. Measurement value processing converts the hardware signals into numeric values, which are converted into physical signals (°C, °F, ...) by linearization/scaling also during measurement value processing. Sensor monitorings (break, overflow, wrong polarity) are also part of measurement value processing.

2.2 Measuring frequency

As the analog-digital converter of the input circuit is common for all 8 controllers, the individual controller inputs are measured cyclically. Each controller input is measured twice per second.

2.3 Sensor types

The sensor type can be determined (also differently) for each controller during configuration. Analog measurement value acquisition includes the following values:

Actual value measurement for 8 controllers.

- thermocouple,
- resistance thermometer,
- DC voltage.

2.3.1 Thermocouples

The following thermocouple types acc. to DIN/EN 60584 can be connected:

TC type	TC material type	Ident. colour neg. wire	Range
L	Fe/Cu-Ni	blue	0...900°C
J	Fe/Cu-Ni	black	0...900°C
K	Ni-Cr/Ni	green	0...1350°C
N	Nicrosil/Nisil	pink	0...1300°C
S	Pt-10Rh/Pt	orange	0...1760°C
R	Pt-13Rh/Pt	white	0...1760°C
T	Cu/Cu-Ni	brown	0...400°C
W *)	W5Re/W26Re	not determined	0...2300°C
E	Ni-Cr/Cu-Ni	violet	0...1000°C

*) not acc. to DIN

The lower measuring limit of KS 800 is 0 mV for all thermocouple types, i.e. 0°C or 32°F. The upper measuring limit is the upper operating temperature of the relevant thermocouple type. The thermocouples are monitored for wrong polarity and break.

Monitoring for wrong polarity responds, when the wrong polarity voltage corresponds to a temperature of -30°C.

2.3.2 Resistance thermometer

Resistance thermometers of type PT 100 to DIN/IEC 751 can be connected in 2 or 3-wire circuit. The lower measuring limit is -100°C . The upper measuring limit is $+850^{\circ}\text{C}$. The thermometer current is approx. 0,25 mA. The resistance thermometer is monitored for lead break and short circuit. A short circuit is with a resistance (thermometer incl. leads) $< 48 \Omega$ (-130°C).

2.3.3 Resistance

Variable resistances within 0 ... 400 Ohm can be used as input signal.

Circuit type: variable resistor, no potentiometer circuit.
Span start and end can be selected freely within the limits specified above.
The sensor current is approx. 0,25mA.
Only lead break monitoring is provided.

Note: Unless used in conjunction with a 2-stage cascade controller, this resistive input cannot be used as position feedback for a 3-point stepping controller: the master controller gets e.g. the temperature as input, the slave gets its set-point by the master and the process value is the resistance at the motor actuator.

2.3.4 DC voltage

DC voltages of -100mV ... $+100\text{mV}$ can be processed.
Lead monitoring for short circuit or wrong polarity is not possible.
Lead break detection is provided.

2.4 Measurement value correction

A method which permits zero offset, gain adjustment both combined by 4 parameters is used.

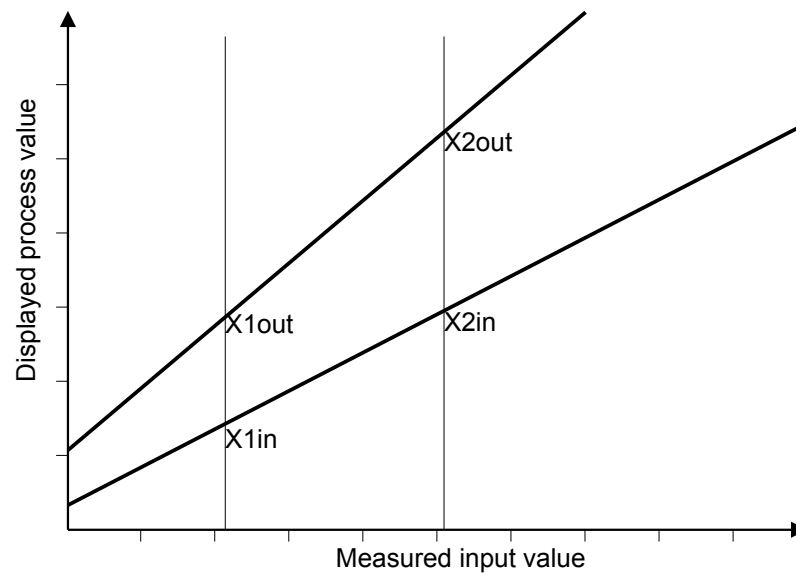

The parameters can be determined for any working points:

- X1in old displayed start value
- X1out corrected start value to be displayed

- X2in old displayed end value
- X2out corrected end value to be displayed

2.4.1 Application examples:

The units can be any variables.

1. Gain adjustment

The straight line from 0 ... 900 shall be 105 instead of 100 in working point 100.
 $x_{1in} = 0$, $x_{1out} = 0$, $x_{2in} = 100$ and $x_{2out} = 105$.

With an input value of 900, the output value is $900 \times 1,05 = 945$.)

2. Zero offset:

The straight line of 0 ... 100 shall be shifted upwards by 5:
 $x_{1in} = 0$, $x_{1out} = 5$, $x_{2in} = 100$, $x_{2out} = 105$

3. Combined gain adjustment and zero offset

The straight line of 0 ... 100 shall be changed into 5 ... 112:
 $x_{1in} = 0$, $x_{1out} = 5$, $x_{2in} = 100$ and $x_{2out} = 112$.

e.g. with an input value of 200, the output value is 219.

2.5 Digital input signal pre-processing

Inputs IN/OUT13 ... IN/OUT16 are provided once per unit and are used as control signals in common for all 8 controllers, provided that they are configured for the relevant control function. The logic level of digital signal inputs which are not connected is 0.

2.5.1 Input signal distribution

Input signal distribution is according to the following tables:

2.5.2 Analog input signals

Input signal hardware	Input signal controller	Remark
IN1...IN8	X1...X8	Actual controller values
HC-k HC-l	HC	Heating current input per controller

2.5.3 Digital input signals

Signal description	Conn. terminal	Active with
Par1/Par2	IN/OUT13	C700_1 = 3
W/W2	IN/OUT16	C190_1 = 1
Coff	IN/OUT14	C190_2 = 1
Leck	IN/OUT15	C500_2 = 4

- Par1/Par2:** Parameter switch-over. Each controller can contain 2 parameter sets, which can be activated by selection. With terminal IN/OUT13 configured as input and set to logic "1", parameter set "2" (Par2) is activated for all controllers which are configured accordingly.
- W/W2:** Set-point switch-over. Each controller can contain 2 set-points, which can be activated by selection. With terminal IN/OUT16 configured as input and set to logic "1", set-point "2" (W2) is activated for all controllers which are configured accordingly. With the input not connected, set-point "1" (W) is effective.
- Coff:** Controller off. With terminal IN/OUT14 configured as input and set to logic "1", all controllers which are configured accordingly are switched off. Alarm or other signalling functions (limit contacts, sensor monitoring, etc.) which may be related to a controller continue operating normally. I.e. only the controller outputs are deactivated, the controller itself continues operating normally. Thus bumpless switch-over back to controller operation is possible.
- Leck:** (Leakage) The output signal of a difference current relay can be connected to terminal IN/OUT15. As the heating leads of all controllers must be looped through this relay, leakage current monitoring for each heating loop is possible. If leakage current monitoring is not necessary, this input need not be connected. The "response time" of the difference current relay must be < 60ms. Further configuration is not necessary. Leakage current monitoring is always active, provided that a corresponding relay is connected.

3 Controller block diagram

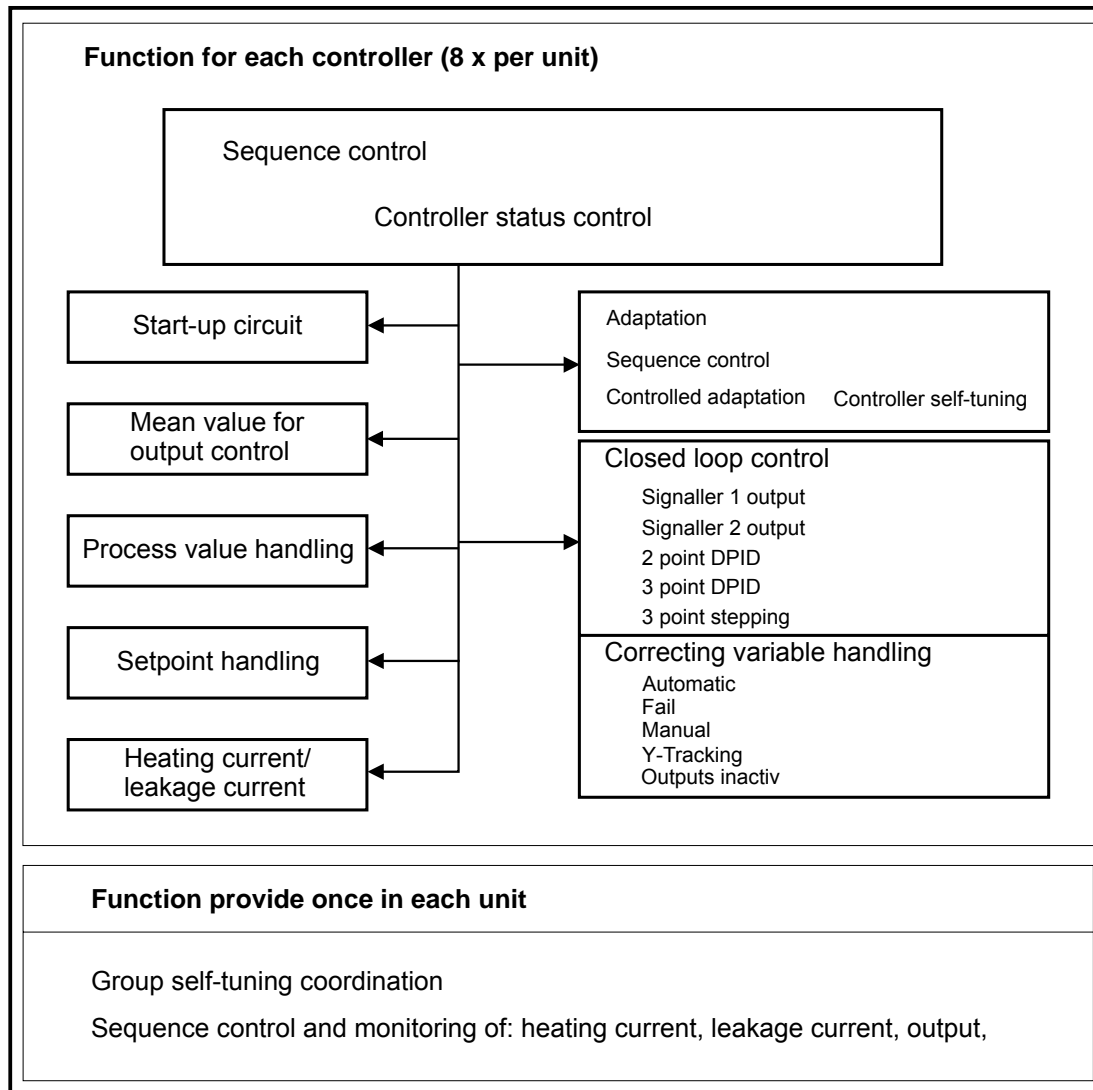

3.1 Sequence control

Several controller statuses which can be switched over via control inputs (configuration C500) or via the interface are possible. However, switching on or off must always be done by the same source.

For instance, after switching over to manual operation via the control input, switching back via the interface is not possible.

After power failure, the operating status is a result of the interface signal stored last (EEPROM content) and of the applied control input according to priorities.

4 Set-point functions

4.1 Set-point control

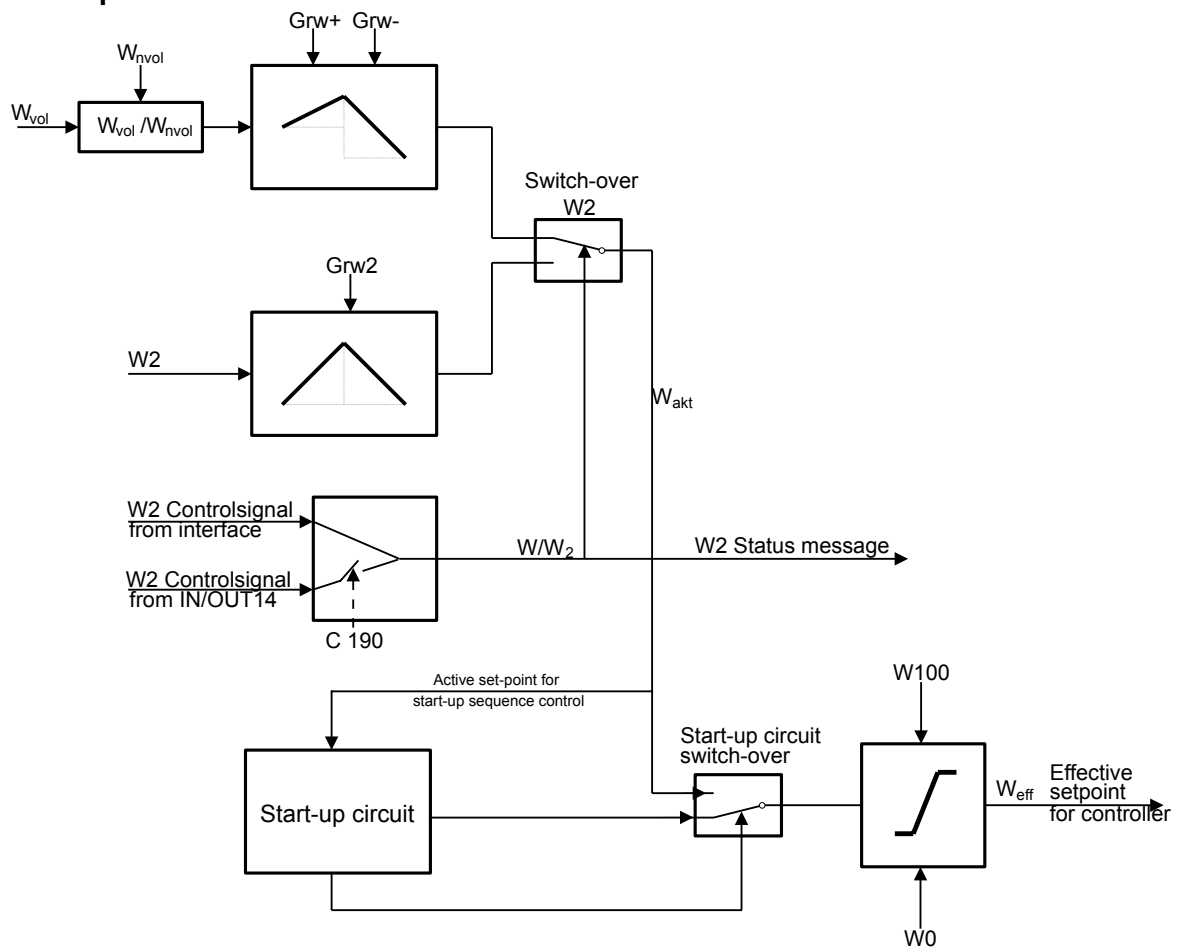

Setpoint processing for set-point control

The effective set-point for KS 800 is handled by various pre-processing functions, before it is used for the control algorithm.

When the controller is switched on, the non-volatile set-point W_{nvol} is effective, i.e. $W_{vol} = W_{nvol}$.

"Volatile" is referred to the data loss in case of supply voltage failure.

The adjustable set-point gradient $Grw+$ is effective, when the set-point is increased: a step increase of the set-point is converted into a ramp by this gradient. $Grw2$ works accordingly with set-point reduction.

$Grw2$ is effective when switching over to and from the 2nd set-point. This gradient is equal for increasing and falling step change.

The second set-point is "non-volatile" with power failure.

Subsequent set-point/2nd set-point switch-over is possible only via serial interface or via interface **and** input IN/OUT14 dependent of configuration.

When activated, the 2nd set-point has the priority. When the 2nd set-point is effective, a status message is output.

This active set-point W_{akt} is evaluated also by the start-up circuit, which decides which set-point is used for start-up according to a separate algorithm: active set-point W_{akt} or a set-point calculated by the start-up circuit.

Before passing to the controller, the set-point is limited to the "adjustment range".

W_0 is the lower and W_{100} the upper limit of the set-point adjustment range. These limits are absolute and cannot be exceeded.

5 Function block protocol

5.1 Data structure

Due to the large variety of information processed in KS 800, logically related data and actions are grouped in function blocks. A function block has input and output data, parameter and configuration data. 41 function blocks are defined for KS 800. They are addressed via fixed block addresses (FB no.). Each block is divided into individual functions. Functions are addressed via function numbers (fct. no.). Function number 0 addresses function-specific data.

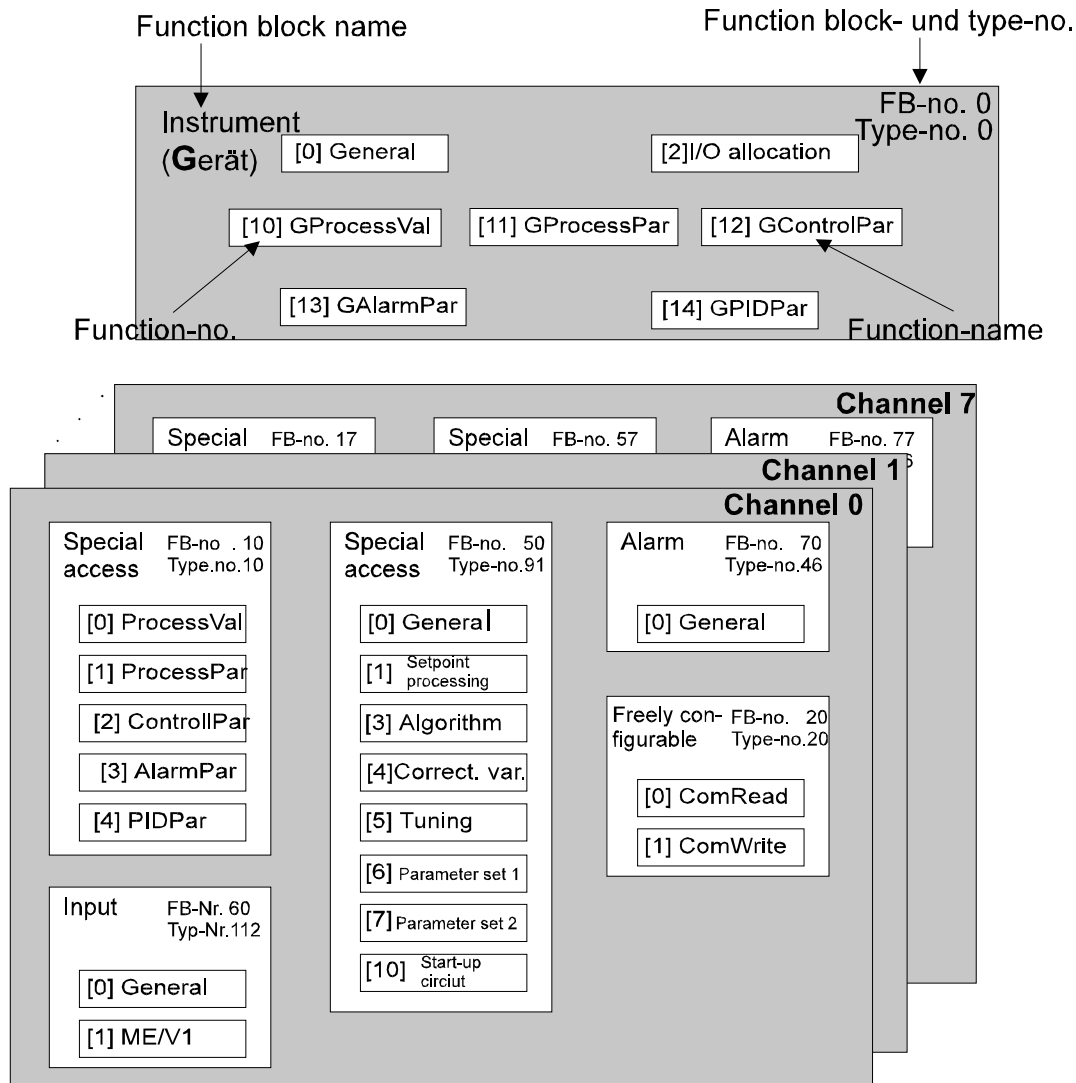

Survey of KS 800 function blocks and functions

Data which are valid for the overall instrument are grouped in this function block.

5.2 Structure of configuration words

The configuration words listed in the following code tables comprise several partial components which can be transmitted only in common. The data in the table must be interpreted as follows:

Code	Descr.	R/W	Type	Description	Range
71	C100	R/W	INT	CFunc: controller function (T, H) WFunc: set-point function	0...xx0z
				Description	
				CFunc	WFunc
				"10 ³ "	"10 ² "
				x	z
				00..07	0...1
				0 2 0 4	

Example: 2-point controller, setpoint/cascade

5.2.1 Function block instrument

Function block Instrument, type no.: 0, function General, function number 0.

All data valid for the overall instrument are grouped in function block "INSTRUMENT".

Process data
General

Function no. 0

Code	Descr.	R/W	Type	Description	Range	Re
01	Unit State 1	R	Bloc	Status 1		A
10	Block 13...15, 18	R	INT			
13	Write error	R	INT	Error of last write access	0,100...127	
14	Write Error Position	R	INT	Position of last write error	0...99	
15	Read Error	R	INT	Error messages of last read access	0, 100...127	
16	DPErr	R	INT	Error messages from DP module		B
17	DPAAdr_eff	R	INT	Effective Profibus address	0...126	
18	Type	R	INT	Type no. of function block	0	
20	Block 21...27	R	INT			
21	HWbas	R	INT	Basic HW Options: Modules A,P		C
23	SWopt	R	INT	Software options		D
24	SWcod	R	INT	Software code number 7th - 10th digit		E
25	SWvers	R	INT	Software code number 11th - 12th digit		E
26	OPVers ¹⁾	R	INT	Operating version		
27	EEPVers ¹⁾	R	INT	EEPROM version		
31	OPMod	R/W	INT	Switch over instrument to configuration mode (only	0	
				Switch over instrument to online mode (only to 0)	1	
				Cancel configuration mode (only to 0)		
32	Ostartg	R/W	INT	Stop/start self-tuning of all group controllers	0...1	
33	UPD	R/W	INT	Acknowledge local data change	0...1	G

¹⁾ Data are given for distinction of internal versions during future use.

To A: Unit State1

MSB							LSB
D7	D6	D5	D4	D3	D2	D1	D0

Bit no.	Name	Allocation	Status "0"	Status "1"
D0	"0"	always "0"		
D1	CNF	instrument status	online	configuration
D2...D4	"0"	always "0"		
D5	UPD	parameter update	no	yes
D6	"1"	always "0"		
D7		parity		

To B: DP Err

MSB														LSB	
D15	D14	D13	D12	D11	D10	D9	D8	D7	D6	D5	D4	D3	D2	D1	D0

Bit no.	Name	Allocation	Status "0"	Status "1"
D0		bus access not successful	no error	error
D1		faulty parameter setting	no error	error
D2		faulty configuration	no error	error
D3		no data communication	no error	error
D4...D15		always "0"		

To C: HWbas

	hwbas			
Digit	1	2	3	4
Description	Basic-hw			hw-out
Definition	always			

Basic-hw:

- (interface version)
- 00: basic version without Com2 (only for internal purposes)
 - 01: Com2 with CANopen / DeviceNet
 - 02: Com2 with PROFIBUS-DP
 - 03: Com2 with ISO 1745

hw-out:

- (optional hardware outputs)
- 0: without analog outputs
 - 1: with current outputs (0/4...20mA)
 - 2: (provided for voltage outputs 0...10V)
 - 3: with 10V reference voltage source + 2 relays

To D: SWopt

Version		0	0
"10 ³ "	"10 ² "	"10"	"1"
Basic version	0	0	0
Water cooling	0	1	0

Basic version	0	0	0	0
Water cooling	0	1	0	0

To E: SWCod

"10 ³ "	"10 ² "	"10"	"1"
7th digit	6th digit	5th digit	4th digit

Example: Value "SWCod = 7239" means that the software for the addressed instrument contains code number 4012 157 **239xx**.

To F: SWVers

"10 ³ "	"10 ² "	"10"	"1"
0	0	11th digit	12th digit

Example: Value "SWVers = 11" means that the software for the addressed instrument contains code number 4012 15x xxx**11**.

To G: UPD

Changing a parameter or a configuration value via an interface is displayed in the UPD flag. This bit is set also after mains recovery. The flag, which can be read also via code UPD, can also be reset (value = 0).

I/O allocation

Code	Descr.	R/W	Type	Description	Range	Rem.
0	Block 1...2	R	Block			
1	State_alarm_out	R	ST1	Status alarm outputs		H
2	State_dio	R	ST1	Status digital inputs/outputs		I
20	Block 21...24	R	Block			
21	SnOEMOpt	R	INT	Series number OEM field		
22	SnFabMonth	R	INT	Series number month of production		
23	SNCntHi	R	INT	Series number HIGH		
24	SnCntio	R	INT	Series number LOW		
30	Block31...33	R	Block			
31	Fdo1	R/W	ICMP	Forced digital outputs: OUT 1...OUT8		J
32	Fdo2	R/W	ICMP	Forced digital outputs: OUT9...OUT16		K
33	Fdo3	R/W	ICMP	Forced digital outputs: OUT17...OUT19		L

To H: State_alarm_out

MSB							LSB
D7	D6	D5	D4	D3	D2	D1	D0

Bit no.	Name	Allocation	Status "0"	Status "1"
D0	R1	Relay 1	off	on
D1	R2	Relay 2	off	on
D2	R3	Relay 3	off	on
D3	do 1...12 AL	Alarm output short circuit OUT1...OUT12	off	on
D4	HCscAL	Alarm output heating current short circuit	off	on
D5	"ß"	always "0"		
D6	"1"	always "1"		
D7		Parity		

To I: State-dio

MSB							LSB
D7	D6	D5	D4	D3	D2	D1	D0

Bit no.	Name	Allocation	Status "0"	Status "1"
D0	Par_Nr	Parameter set number	set 0	set 1
D1	W/W2	W/W2 switch over	W	W2
D2	Coff	Controller off	off	on
D3	Leck	Leakage current	off	on
D4	"0"	always "0"		
D5	do13...16f	OUT13...OUT16Fail	no	yes
D6	always "1"	always "1"		
D7	Parity			

To I: Data structure

Bit	15	14	13	12	11	10	9	8	7	6	5	4	3	2	1	0
Signification	0	0	0	0	0	0	0	0	OUT8	OUT7	OUT6	OUT5	OUT4	OUT3	OUT2	OUT

To K: Data structure

Bit	15	14	13	12	11	10	9	8	7	6	5	4	3	2	1	0
Signification	0	0	0	0	0	0	0	0	OUT6 16	OUT 15	OUT 14	OUT 13	OUT 12	OUT 11	OUT 10	OUT 9

To L: Data structur

Bit	15	14	13	12	11	10	9	8	7	6	5	4	3	2	1	0
Signification	0	0	0	0	0	0	0	0	0	0	0	0		OUT 19	OUT 18	OUT 17

6 Controller statuses and status priorities

The priorities are sorted according to ascending order (0=low; 7=high)

6.1 Priority 0 automatic (low)

The controller is in automatic mode (control operation). Set-point definition is possible.

6.2 Priority 1 Tune, run

Self-tuning is active and handles the self-tuning procedure independently.

Starting is done via the interface with Ostart = 1, stopping is done with Ostart = 0. The start/stop signal can also be generated internally by the control function itself with group self-tuning configured (see section Group self-tuning).

Function block controller type no: 91, function General, function number 0.

Abbr.	Description	Range
OStart	Self-tuning start	0..1
Status	Status 1	Single bit

When self-tuning is running, a status message State_Tune1 is generated (Orun = 1) and can be evaluated as individual bit. Self-tuning can always be switched off via the interface with Ostart=0. When a controller operating status with higher priority is requested whilst self-tuning is running, self-tuning is cancelled immediately and the controller changes to this mode.

Function block controller type no.: 91, function Tuning, function number 5.

Abbr.	Description	Range
State_Tune1	Status tuning 1	Single bit
YOptm	Correcting variable during process at rest	-105...105 %

Whilst self-tuning is active, the set-point can be changed via the interface. After successful self-tuning, the self-tuning status is left and the controller changes over to automatic mode.

With self-tuning start from automatic mode, the stable correcting variable (YOptm) is output and the controller waits, until the process is at rest.

With self-tuning start from the manual mode, the actually adjusted manual correcting variable is output for "process at rest".

The process is at rest, when variable X is within a tolerance band of $\pm 0,5\%$ of the span of the chosen sensor during more than 90 seconds.

6.3 Priority 2 Tune, error

When the controller self-tuning was finished or cancelled with an error, the controller switches over to manual mode and outputs a constant correcting variable with the value of stable correcting variable YOptm. Adjustment of the manual correcting value via interface is **not** possible in this status.

The status must be confirmed by the user and set to 0 by Ostart.

Self-tuning can be finished in three possible ways:

- 1 controller switch-over to manual via the interface.
- 2 by Ostart = 0 via the interface.
Stopping group self-tuning when the controller participates in group self-tuning. Hereby, the stop signal is generated internally by the control function (see section Group self-tuning).
- 3 Coff, i.e. controller switch-off.

6.4 Priority 3 Sensor break

With sensor break (variable X), the controller is set to manual and the pre-configured correcting variable is output (additional controller configuration C101_2). The correcting variable can be changed according to the selected configuration. When leaving status sensor break, the controller is initialized.

In case "no fail behaviour" (no controller reaction) is configured (C101_2 = 6), the fail signal of input X is not evaluated. The configured substitute value of the input (Xfail from configuration C213) is always used as measurement value for control, independent of whether the input measurement is or is not in error status.

Function block input type no.: 112, function MV/V1, function number 1.

Abbr.	Description	Range	Default
XFail	Substitute value with sensor failure	-999...9999	0

6.5 Priority 5 Manual

In this status, the controller is switched over to the manual mode bumplessly. (The last controller correcting variable remains unchanged). The correcting variable can be defined absolutely or relatively via the interface; the rate of change (Ygrw_Is) is adjustable in two steps:

0 = slow = 100% in 40 sec; 1 = fast = 100% in 20 sec.

(With three-point stepping controller, only a relative correcting variable is possible.)

Function block controller type no.: 91, function Correcting variable, function number 4.

Abbr.	Description	Range	Default
Yman	Absolute correcting variable	-105...105 %	Y)
dyman	Differential correcting variable	-210...210 %	0
Yinc	Incremental correcting variable adjustment	0 = off 1 = on	0
Ydec	Decremental correcting variable adjustment	0 = off 1 = on	0
Ygrw_Is	Speed for incr. or decr. correcting variable adjustment	0 = slow 1 = fast	0

^{*)} Yman is updated continuously by the controller, so that switch-over to "manual" is bumpless.

6.6 Priority 7 Y_Track

During the Y_Track status, the controller tracks the correcting variable to a pre-defined value. The function is handled internally by the controller. The operating principle is described exactly in section Cascade control.

6.7 Priority 8 Controller off (high)

There are 4 possibilities the controller can be switched off:

Scoff: (switch off controller outputs of control function)

- 0: controller can be switched off only via the interface, separately for each individual controller
- 1: controller can be switched off via control input IN/OUT14 and via interface **(0=on; 1=off)**
- 2: controller switched off continuously, enable for heating and cooling output forcing
- 3: inverse function of 1 via IN/OUT14 **(0=off; 1=on)**

Determination is in "C 190 digital allocation", section 19.2.4

For activating controller switch-off, which is not done by configuration,

1. apply an external voltage , or
2. activate set-point -32000.

Controller switch-off means that the controllers are switched to manual operation and correcting variable 0% is output for all outputs. In this mode, the correcting variable cannot be changed. Measurement value acquisition and controllers continue operating. This applies for all controller types.

7 Automatic - manual switch-over

According to determination, automatic - manual switch-over via the interface is possible. The controller statuses resulting from the signal priority are as follows:

Priority				Controller status
8	7	5	3	
Controller off	Y-Track	Controller manual	Sensor failure	
0	0	0	0	Automatic
0	0	0	1	Sensor failure
0	1	0	0	Y-Track
0	1	0	1	Y-Track
0	0	1	0	Manual
0	0	1	1	Manual
0	1	1	0	Y-Track
0	1	1	1	Y-Track
1	x	x	x	Controller off

The operating status after power failure is dependent of the interface signals stored last (EEPROM). Automatic/manual switch-over is bumpless. The last correcting variable calculated by the controller is output as effective manual value. With controller re-start, YHand is initialized with 0%.

With several simultaneous statuses, the status with the highest priority is effective.

There are three methods for adjusting the manual correcting variable:

- Absolute adjustment:**
Absolute manual correcting value (Yman). This adjustment is not applicable for three-point stepping controller.
- Differential adjustment:**
Adjustment of the value for changing the correcting variable (dYman).
- Incremental adjustment:**
Values for incremental adjustment (positive direction Yinc, negative direction Ydec, Ygrw_l_s). Signal ...Ygrw_ls selects the speed of incremental adjustment (slow = 40 sec, fast = 10 sec for 100% change). These data are only valid for 2 and 3-point controller; with three-point stepping controllers, the speed is determined by the motor actuator.

Function block controller type no.: 91, function Correcting variable, function number 4.

Abbr.	Description	Range	Remarks
dYman	Differential correcting variable	-210...210	
Yman	Absolute correcting variable	-105...105	
Yinc	Increm. corr. variable adjustm.	0	0 = off
		1	1 = on
Ydec	Decrem. corr. variable adjustm.	0	0 = off
		1	1 = on
Ygrw_ls	Speed for incr. / decr. correcting variable adjustment	0	0 = slow
		1	1 = fast

8 Self-tuning for single-loop controllers

For determination of the optimum control parameters, controller self-tuning is possible. Optimization can be started and finished from automatic or manual mode. It is also active with the start-up circuit configured.

8.1 Preparation for controller self-tuning:

Controller self-tuning is independent of the selected output type (continuous, switching or mixed).

The control behaviour (DPID, PT, PD or P) can be selected by the user by switching off control parameters before self-tuning start.

Control behaviour	switched off
DPID	none
PI	Tv=0
PD	Tn=0
P	Tn=0 and Tv=0

- ▶ Determine which parameter set shall be activated (P_{Opt}).
- ▶ Determine the **stable correcting variable** Y_{Optm}.
- ▶ Determine **correcting variable step change** dY_{opt}.
- ▶ Determine the "process at rest" mode (main configuration C700).

8.1.1 Process at rest

"Process at rest" monitoring is always done. The process is at rest with process value X in a tolerance band of $\pm 0,5\%$ of the measuring span of the chosen sensor, during more than 90 seconds. When exceeding this band, the watchdog timer is set to zero and the time must run off again.

With extended "process at rest", monitoring is not for a constant control variable, but for a evenly changing input variable X (gradient).

8.1.2 Selecting the stable correcting variable

The stable correcting variable must be selected so that there is a sufficient difference between actual process value and effective set-point when self-tuning starts. The difference between process value and set-point must be $\geq 10\%$ of W₀ / W₁₀₀.

For some applications, identification using a known correcting variable step can be an advantage. This dY_{opt} is specified in % of the active correcting variable. With e.g. a stable correcting variable Y_{Optm} = 20% and a dY_{opt} of 50%, the effective correcting variable changes from 20% by 50% to 70% at self-tuning start.

Function block controller type no.: 91, function Tuning, function number 5.

Abbr.	Description	Range	Default
Y _{Optm}	Stable correcting variable	-100...100%	0
dY _{opt}	Step height at identification *)	5...100%	100%
P _{Opt}	Parameter set to be optimized	0...1	0

*) for heating and cooling

8.1.3 Start from automatic mode

After starting, the stable correcting variable Y_{Optm} is output and the controller waits, until the process is at rest. When "process at rest" was detected, self-tuning starts automatically. During this time, the set-point can be changed.

When the "process at rest" condition is met during control mode, the difference between stable correcting variable Y_{Optm} and the last controller correcting variable can be considerable at self-tuning start. In this case, the controller must wait until the full "process at rest" time has elapsed, because this correcting variable change causes also a process value change within the monitoring time. The ideal case is that stable correcting variable Y_{opt} and last active controller correcting variable during automatic mode are equal.

8.1.4 Start from manual mode

When switching over to manual mode, the correcting variable output last is used by the controller. This correcting value can be changed as required. When self-tuning starts, this correcting variable is used and output as stable correcting variable Y_{Optm} . Subsequently, the controller waits, until "process at rest" is reached and optimization starts automatically. If the process is already at rest at starting time, the waiting time of 60s is omitted, if the last correcting variable was 5 to 10 % of the stable correcting variable. As during automatic mode, the set-point can be changed at any time.

After successful self-tuning, the controller switches over to automatic mode. The controller determines the parameters for the required control behaviour based on process characteristics Tu_1 , V_{max1} and Tu_2 , V_{max2} . The control behaviour (DPID, PI, PD or P) can be selected by the user by switching off $T_n=0$ or $T_v=0$ before self-tuning start. The determined parameters are stored in selected parameter set P_{Opt} and are available to the user via the interface.

When self-tuning is finished with an error, the stable correcting variable Y_{Optm} is output, until self-tuning is finished by the user. ($O_{start} = 0$)

8.2 Self-tuning procedure with heating (2-point and three-point stepping controller)

After reaching "process at rest", the process is stimulated with a correcting variable step change and Tu_1 and V_{max1} are determined from the process reaction, if possible, at the reversal point of the step response. Self-tuning start with controllers which participate in group self-tuning is described in "Self-tuning several controllers in a group".

8.3 Self-tuning procedure with heating and cooling processes: (3-point controller)

At first, self-tuning runs as with a "heating" process. After the end of the heating attempt, controller parameter determination is based on the process characteristics. These parameters are used for lining out to the set-point, until "process at rest" is reached again. Subsequently, a step change to cooling is output for determination of the controller cooling parameters using process characteristics Tu_2 and V_{max2} . The set-point for the cooling attempt is the starting point of the heating attempt. Starting the cooling attempt with controllers which participate in group self-tuning is described in "Self-tuning several controllers in a group".

8.4 Set-point monitoring

For keeping the process at a safe state, continuous monitoring prevents the set-point from being exceeded. When exceeding the set-point, self-tuning is cancelled, an error message is generated, the controller switches over to manual mode and the stable correcting variable YOptm is output.

8.5 Self-tuning several controllers in a group

With configuration C700_2, the controllers belonging to a group can be classified in a group. Only one group with up to 8 controllers per instrument is possible. Group self-tuning is started by the interface with the (instrument-specific) input signal Ostartg.

Function block instrument type no.: 0, function General, function number 0.

Abbr.	Description	Range
Ostartg	Self-tuning stop and start of all group controllers	0
		1

8.5.1 Starting the group self-tuning

Group self-tuning is started by setting signal Ostartg = 1 via the interface. For starting the group, all controllers must have reached the "process at rest" condition". The self-tuning coordination function sets the start signals of the individual controllers to start controller self-tuning.

The coordination function tries to start self-tuning of all group controllers without consideration of the actually valid controller status. If starting is not permitted for a controller due to a higher priority, the sequence control rejects the request and resets signal Ostart to 0.

8.5.2 Group self-tuning stop

When re-setting control signal Ostartg to 0 via the interface whilst group self-tuning is active, all active group self-tunings are cancelled simultaneously. For this purpose, the control signals of the individual controllers Ostart are set to 0 by the coordination function.

The self-tunings of the individual control loops in a group are finished as in single mode, whereby self-tuning control signal Ostart is reset to 0. When all self-tunings of a group are finished, the coordinator function resets the control signal for group start Ostartg to 0.

8.5.3 Common start of the heating attempt for all controllers of a group

When all controllers of a group for which self-tuning is running signal readiness to start the heating attempt ("process at rest"), enabling for the heating attempt is output simultaneously to all active self-tunings of the group. Group controllers which signal faulty self-tuning do not prevent enabling of the attempt.

8.5.4 Common start of the cooling attempt for all 3-point heating/cooling controllers

After group controller self-tuning was started by the coordination function, no further controller coordination is required.

Exception: If 3-point heating/ cooling controllers participate in the attempt, the cooling attempt of these controllers is started in common by the coordinator function.

Thereby, cooling attempt start enabling is as follows:

When all 3-point heating / cooling controllers of the group for which self-tuning is active signal readiness to start the cooling attempt and all other group controllers have finished or cancelled self-tuning, the coordinator functions enables the cooling attempt for all active self-tunings of the group simultaneously.

When a 3-point heating/ cooling controller of the group is started in single mode via the interface by setting signal Ostart = 1, the cooling attempt is enabled immediately.

8.5.5 Signification of self-tuning messages

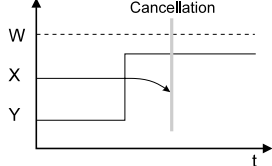
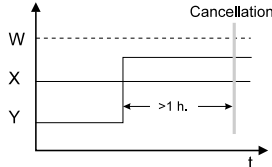
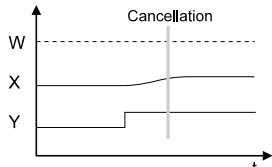
Msg.	Signification or error cause	Possible solution
0	No attempt was made or attempt cancelled by switching over to automatic.	
1	<p>Cancellation: Wrong action of correction variable, X does not change towards W.</p> 	Change controller output action.
2	<p>Finished: Selftuning was succesful (reversal point found; safe estimation)</p>	
3	<p>Cancellation: The process does not react or reacts too slowly (change of ΔX below 1% during 1 h).</p> 	Close the control-loop. Regelkreis schließen.
4	<p>Finished: (low reversal point) Cancellation: Stimulation insufficient (reversal point found; unsafe estimation).</p> 	Increase set-point step dY_{opt} .

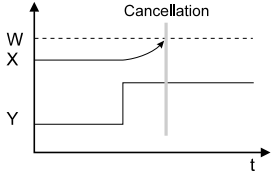
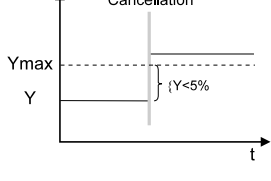
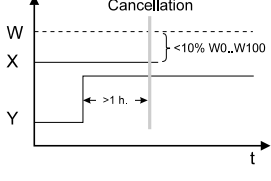
5	Cancellation: Optimisation cancelled due to exceeded set-point risk.		Increase separation of process value (X) and set-point (W) during start-up.
6	Finished: Optimisation cancelled due to exceeded set-point risk (reversal point not reached so far safe estimation).		
7	Cancellation: Insufficient output step, $\Delta Y < 5\%$.		increase Y_{max} or reduce Y_{Optm} .
8	Cancellation: Set-point reserve insufficient or set-point exceeded during PIR monitoring.		Change stable correcting variable Y_{Optm} .

Optimization attempts the message of which starts with **Finished** were successful. New control parameters were determined and activated.

Optimization attempts the message of which starts with **Cancellation** were not successful. The old control parameters remain unchanged.

9 Controlled adaptation

The "controlled adaptation" is provided for the cases, in which the controller characteristics must be changed during controlling. There are two parameter sets which can be switched over via the interface or via a digital control signal. The two parameter sets contain default values (see table of parameter sets) and can be changed or selected via the interface.

During self-tuning, determination which controller parameter set shall be optimized is possible (POpt). Thus the optimum parameter set for the operating statuses can be determined and switched over by the corresponding switch-over criterion.

Function block controller type no.:91, function Tuning, function number 5

Abbr.	Description	Range	Default
ParNr	Effective parameter set number	0...1	0
POpt	Parameter set to be optimized	0...1	0

9.1 Control function parameters

The default parameters marked with x are adjusted dependent of version.

Parameter	Signaller 1 output 2 outputs		2-pnt. contr.	3-pnt. con- troller heat./cool.	3-pnt. stepp.con- troller	Range	Default
	0	1	2	3	7		
Xp1			x	x	x	0,1...999,9	100
Xp2				x		0,1...999,9	100
Tn1			x	x	x	0...9999	10
Tv1			x	x	x	0...9999	10
T1			x	x		0,4...999,9	5
T2				x		0,4...999,9	5
xsh1				x		0,0...999,9	0
xsh2				x		0,0...999,9	0
xsh					x	0,2...999,9	0,2
Tm					x	10...9999	30
Tpuls						0,1...999,9	-32000
Xsd1	x	x				0,1...999,9	1
LW		x				-999...9999	-32000
Xsd2		x				0,1...2,0	1
Ymin.			x	x		0...100 -100...100	0 -100
Ymax.			x	x		0...100 -100...100	0 100
Y0			x	x		0...100 -100...100	0
W0	x	x	x	x	x	-999...9999	0
W100	x	x	x	x	x	-999...9999	900
W2	x	x	x	x	x	-999...9999	100
Grw+	x	x	x	x	x	0...9999, ----	----
Grw-	x	x	x	x	x	0...9999, ----	----
Grw2	x	x	x	x	x	0...9999, ----	----

10 Signaller

Signalling function

The signalling function is a controller function and must be specified for each individual controller by configuration C100_3.

This configuration can be used for processes with low T_u and small V_{max} . The control oscillations can be determined by:

$$X_0 = X_{max} \times T_u/T_g + X_{sd} = v_{max} + T_u + X_{sd}$$

The signalling function is used for limit signalling, whereby the setpoint is the limit value. The trigger point is symmetrical to the set-point; hysteresis X_{sd1} is adjustable.

The signaller with two outputs has an additional "high and low alarm trigger point". Its separation from the set-point is adjusted with parameter LW (including polarity sign). The following diagrams show the static characteristics for "inverse" and "direct" action. Determination of the controller actions is in configuration C101_4.

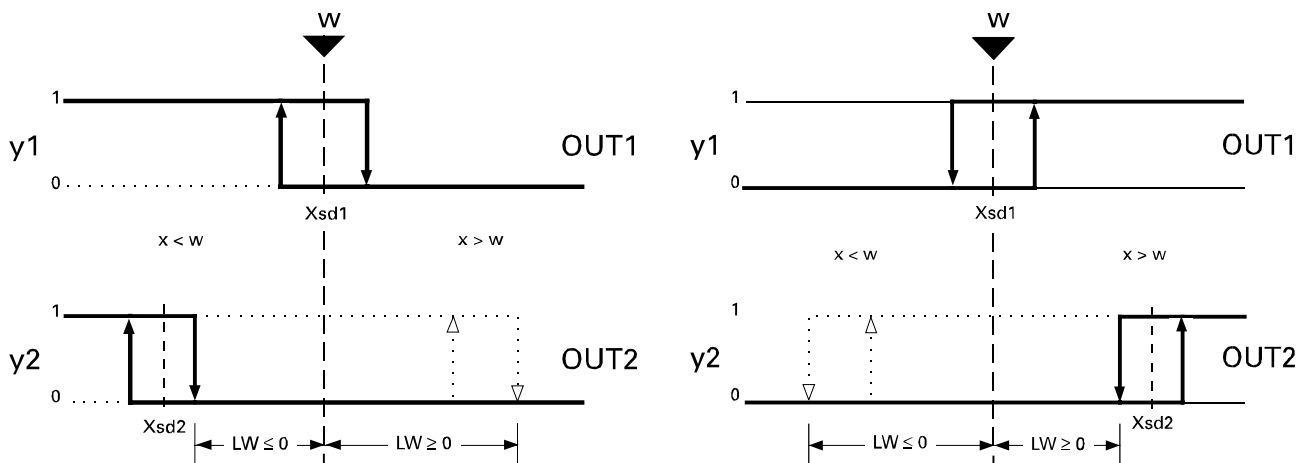

The parameters required for the signaller are transferred from:

Function block controller type no.:91, function Algorithm, function number 3.

Abbr.	Description	Range	Default
Xsd1	Signaller switching differential	0,1...9999	1
LW	Trigger point separation additional contact	-999...9999	0
Xsd2	Addition.contact switch.differential	0,1...9999	1

11 Two-point controller

The parameters required for this controller are transferred from:

Function block controller type no.:91, function Parameter set x, function number 6 and 7.

(Function number 6 = parameter set 1; function number 7 = parameter set 2)

Abbr.	Description	Range	Default
Xp1	Proportional band 1	0,1...999,9%	100%
Tn1	Integral time 1	0...9999 sec	10sec
Tv1	Derivative time 1	0...9999 sec	10sec
T1	Min. cycle time	0,4...999,9sec	5sec

The parameters required for this controller are transferred from:

Function block controller type no.:91, function Correcting variable, function number 4.

Abbr.	Description	Range	Default
Ymin	Min. corr. variable limiting	-100...100 %	0 %
Ymax	Max. corr. variable limiting	-100...100 %	100 %
Y0	Working point for corr. variable	-100...100 %	0 %

Determination of the controller action is in configuration C101_4.

The cycle time T_1 is the minimum cycle time (time in seconds) at 50 % duty cycle. For optimization according to the control behaviour, the hints given in table Parameter characteristics must be followed.

Parameter characteristics (two-point / three-point controller)

Parameter	Setting	Control and line-out of disturbances	Start-up behaviour
Xp1	higher	increased damping and slower line-out of disturbances	slower reduction of duty cycle and possible overshoot of set-point
	lower	reduced damping and fast line-out of disturbances, increase Xp if process starts oscillating	fast reduction of duty cycle, increase Xp, if line-out oscillates
Tn	higher	increased damping, slower line-out of disturbances	slow change of duty cycle
	lower	reduced damping, faster line-out of disturbances; if the stability becomes too low: increase Xp	faster change of duty cycle
Tv	higher	reduced damping and faster response to disturbances	early switch-off downscale of set-point with possible overshoot
	lower	increased damping with slower response to disturbances	late switch-off downscale of set-point with possible overshoot

PD behaviour ($T_n = 0$)

The working point is the point in which $X=W$ output $Y = 0 + Y_0$.

For keeping the process lined out, a certain amount of energy dependent of set-point is necessary. This results in a permanent offset, which will increase with higher values for X_{p1} .

DPID behaviour ($T_n \geq 0$) By means of the integral action, the process is lined out without permanent offset.

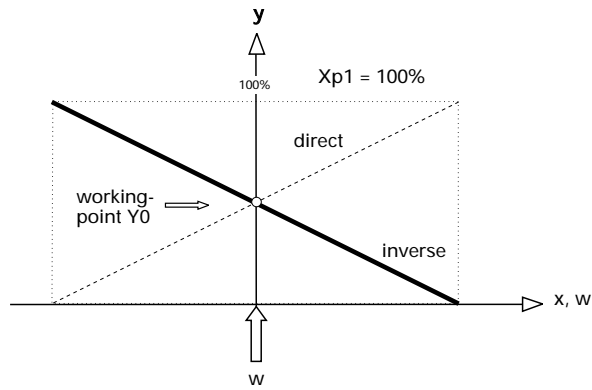

The static characteristic of the two-point controller is identical with the one of the continuous controller. The difference is that a duty cycle instead of a linearly variable current signal is output (relay contact, control output 0/24V).

Working point Y0 and cycle time T1 at 50% duty cycle are adjustable. The shortest switch-on or switch-off time is approx. 63ms.

12 Three-point DPID controller

The parameters required for this controller are transferred from:

Function block controller type no.:91, function Paramset x, function number 6,7.

Abbr.	Description	Range	Default
Xp1	Proportional band 1	0,1...999,9 %	100 %
Tn1	Integral time 1	0...9999 sec	10 sec
Tv1	Derivative time 1	0...9999 sec	10 sec
T1	Min. cycle time 1	0,4...999,9 sec	5 sec
Xp2	Proportional band 2	0,1...999,9 %	100 %
Tn2	Integral time 2	0...9999 sec	10 sec
Tv2	Derivative time 2	0...9999 sec	10 sec
T2	If configured as a 3-point-stepping controller: min. cycle time: 2 If configured as a 3-point-controller with water cooling: Min. switch-off pulse duration with Y_{PID} in sec	0,4...999,9 sec	5 sec

Function block controller type no.:91, function Correcting variable, function number 4.

Abbr.	Description	Range	Default
Ymin	Min. corr.variable limiting	$0 \dots (Y_{max}-1)$	-100
Ymax	Max. corr.variable limiting	$(Y_{min}+1) \dots 100\%$	100
Y0	Working point for corr.variable	$Y_{min} \dots Y_{max}$	0

Function block controller type no.:91, function Algorithm, function number 3

Abbr.	Description	Range	Default
Xsh1	Neutral zone	0,0...999,9%	0
Xsh2	Neutral zone	0,0...999,9%	0

Determination of the controller action is in configuration C101_4.

Cycle time T1 and T2 correspond to the minimum cycle times at 50% duty cycle. For optimization according to the control behaviour, the hints given in Tab.: Parameter characteristic must be followed.

PD/PD behaviour ($T_n = 0$)

The adjustment range reaches from 100% heating (switching output 1) to -100% cooling (switching output 2).

The proportional bands must be matched to the different heating and cooling range. For keeping the process lined out, a certain amount of energy dependent of set-point is required. This results in a permanent offset, which will increase with higher values for $X_p(1,2)$.

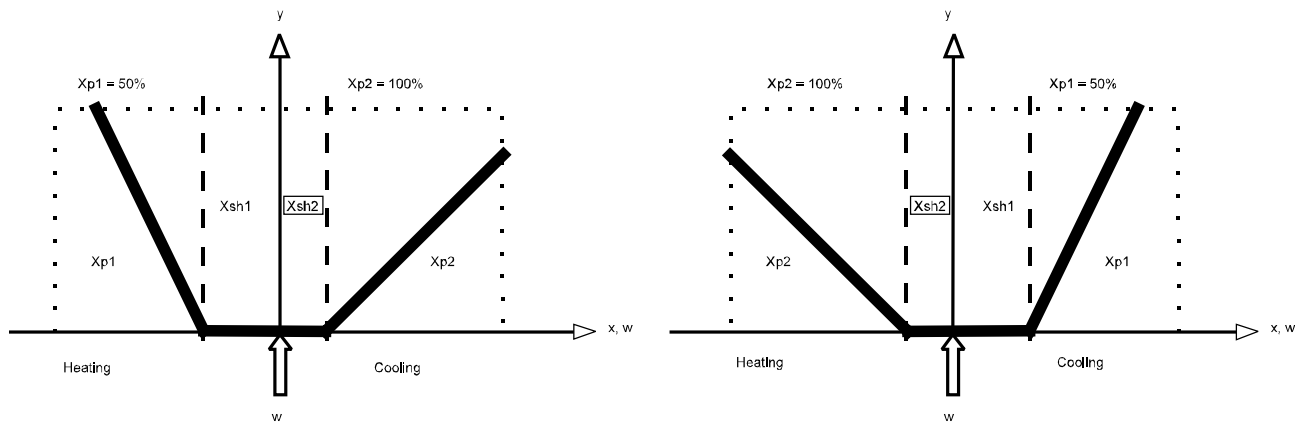

The figures show the static characteristic for inverse and direct action with $T_n = 0$. Direct / inverse switch-over only causes an exchange of the outputs for "heating/cooling". The terms "heating" and "cooling" are used accordingly for all similar processes (batching acid/lye, ...). The neutral zone is adjustable separately for the trigger points (X_{sh1} , X_{sh2}) and need not be symmetrical to the set-point.

DPID/DPID behaviour

By means of the integral action ($T_n > 0$), the process is lined out without permanent offset. The proportional bands must be matched to the different heating and cooling rates and can have different X_p ranges. The transition from trigger point 1 (heating) to trigger point 2 (cooling) is dependent of neutral zone X_{sh1} , X_{sh2} . When the process is within the neutral zone, the actual correcting variable remains unchanged, until this zone is left again.

13 Three-point stepping controller

In order to match the adjusted X_{p1} to the motor actuator travel time, the travel time T_m must be adjusted. The smallest positioning step of the controller is 0,1sec.

Adjusting the neutral zone

With excessively frequent output switching, the neutral zone X_{sh} can be increased. Note, however, that an increased neutral zone will cause a decrease of the control sensitivity. Therefore, we recommend to optimize switching frequency (wear of external relays/contactors and motor actuator) and control behaviour.

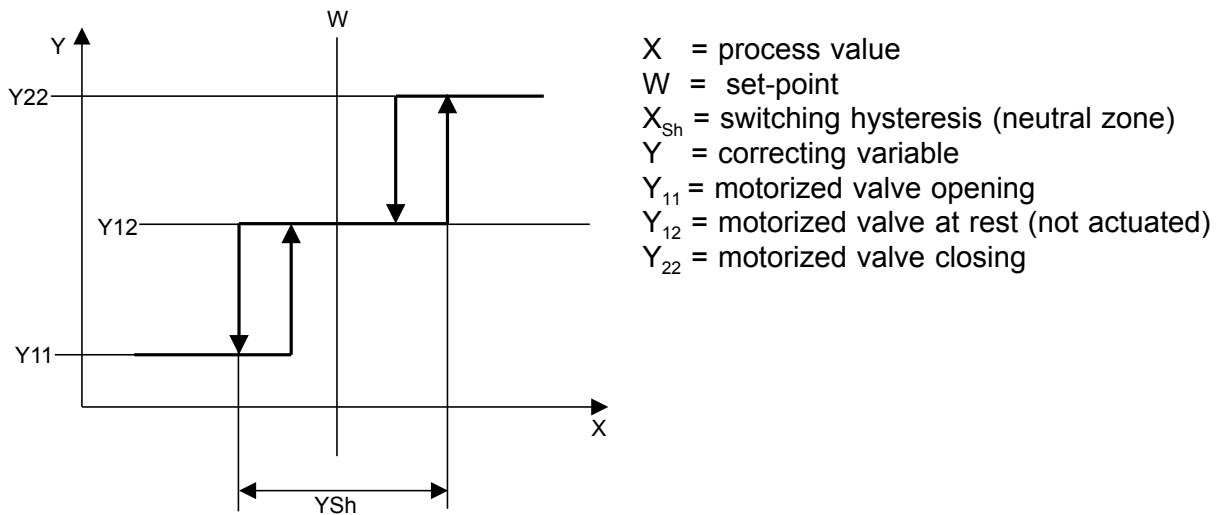

Parameter adjustment effects of three-point stepping controller:

Parameter	Setting	Effect
X_{p1}	higher	shorter positioning steps, increased stability, slower line-out of
	lower	longer positioning steps, reduced stability, faster line-out of
T_n	higher	longer pauses between two positioning steps, improved stabi-
	lower	shorter pauses between two positioning steps, reduced stabili-
T_v	higher	positioning steps larger, and reduced stability
	optimal	improved stability

In the figure below, the static characteristics of the three-point stepping controller configured as inverse and direct is shown. The hysteresis shown in this figure is practically without importance, however, it can be calculated from the adjustable pulse length $T_{puls} < 10ms$.

$$X_{sh} = (T_{puls}/2) \times 0,1 \times (X_p/T_m) \quad \text{units: } X_{sh} = \text{sec}, T_{puls} = \text{sec}, X_p = \%, T_m = \text{sec}$$

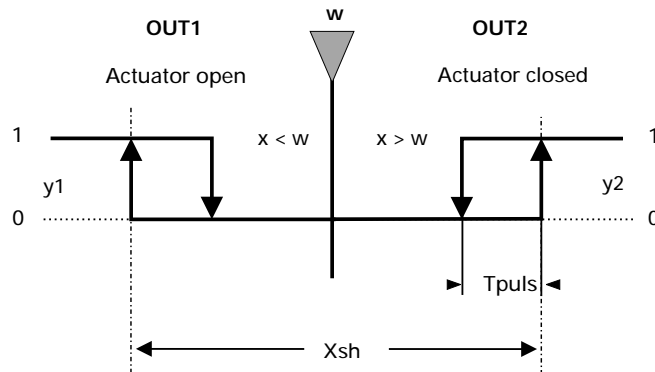

Configuration example: control of a room temperature with a motorized valve

Input PT100	Set-point range 10 to 60°C
Controller structure	Three-point stepping controller, inverse action, differentiate X_w
Alarms	Sensor failure or measurement value alarm, measurement value alarm relative limit contact X_w low and high alarm output on rel.1 -15K ... +15K $X_{sd1} = 0,5K$ low low and high high alarm output on rel.2 -4,5K... +4,5K $X_{sd1} = 0,5K$ Sensor failure: output on relay 3 Action with sensor failure: close valve

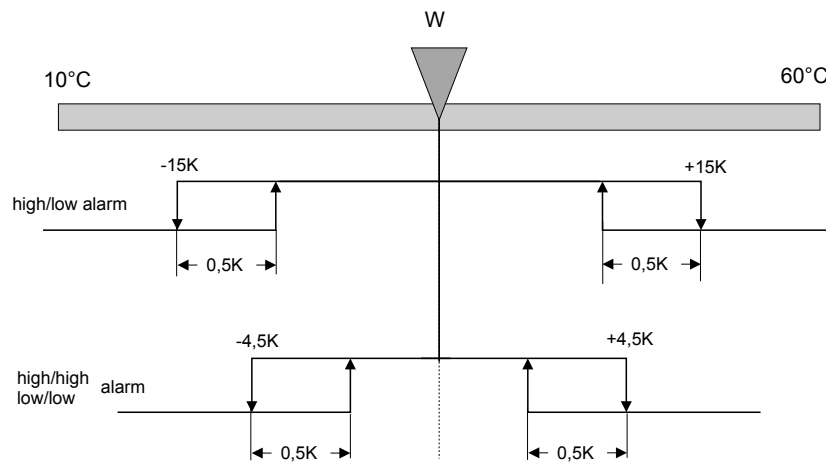

Configuration input:

Sensor type	main configuration C200 resistance thermometer type 20, unit 1
Set-point range	function block controller type no.:91, function set-point processing function no.: 1
$W_0 = 10, W_{100} = 60$	

Controller structure:

Three-point stepping controller

Controller configuration C101 CMode 0, CDiff 0, Cfail 1, CAnf 0

Controller configuration C100 CFunc 07, CType 0, Wfunc 0

Function block controller type no.:91, function Algorithm function no.: 3

Xsh neutral zone in % referred to X0...X100 of variable input 1

Tm actuator response time in sec

Tpuls min. pulse length in sec

Function block controller type no.:91, function Paramset x function no.: 6,7

Xp1 proportional band 1 in % referred to X0...X100 variable input 1

Tn1 integral time in sec

Tv1 derivative time in sec

Alarms:

Relative limit contact

Main configuration C600 Src 02, Fnc 2, DestFail 3,

Main configuration C601 DestLL 1, DestL 1, DestH 2, DestHH 2

Function block alarm type no.:46,

Function General function no.: 0

LimL = -15, LimH = +15 Xsd1 = 0,5 LimLL = -4,5, LimHH = +4,5

14 Forcing of switching outputs

Input and output "forcing" means determination of the input or output level from a control system. With KS 800, the outputs for heating (OUT1...OUT8) and cooling (OUT9...OUT12 and IN/OUT13...IN/OUT16) can be "forced" (only output forcing).

As a general rule, outputs which are not used for a control function are enabled for forcing:

The heating outputs are enabled for forcing provided that one of the following conditions is met:

Controller	= switched off continuously, or
Control function	= three-point controller (continuous/switching), or
Control function	= continuous controller, or
Control function	= three-point controller (continuous/switching)

The cooling outputs are enabled for forcing, provided that one of the following conditions is met:

Controller	= switched off continuously, or
Control function	= signaller with one output (switching), or
Control function	= two-point controller (switching), or
Control function	= three-point controller (switching/continuous), or
Control function	= continuous controller, or
Control function	= three-point controller (continuous/continuous)

Analog outputs are enabled for forcing under the following conditions:

- The unit is fitted with option "analog outputs"
- Operating version 5, or higher
- The output is not used for output of a controller variable.

Note: The output range dead zero (0...20mA) or live zero (4...20mA) is determined in common for all analog outputs (in C904) and is independent of the use (allocation) of the individual outputs.

The relevant configuration is described in:

- C190 digital signal allocation**
- C500 signal inputs/outputs IN/OUT13...IN/OUT16**

15 Continuous controllers

With KS 800, up to 8 outputs can be used as continuous controllers. Standard current or standard voltage output signal is dependent of hardware.

With standard current signal, switch-over between "dead zero" (0...20 mA) or "live zero" (4...20 mA) is possible via software.

The parameters required for this controller are transmitted from:

Function block controller type no.:91, function paramset x, function number 6 and 7.
(function number 6 = parameter set 1; function number 7 = parameter set 2)

Abbr.	Description	Range	Default
Xp1	Proportional band 1	0,1...999,9%	100 %
Tn1	Integral time 1	0...9999sec	10sec
Tv1	Derivative time 1	0...9999sec	10sec
T1	min. cycle time	0,4...999,9sec	5sec

The parameters required for this controller are transmitted from:

Function block controller type no.:91, function correcting variable, function number 4.

Name	Description	Range	Default
Ymin	min. output limiting	0...100 %	0 %
Ymax	max. output limiting	0...100 %	100 %
Y0	working point for correcting variable	0...100 %	0 %

Determination of the controller action is in configuration C101_4.

For optimization according to the control response, the hints given in table Parameter characteristic must be followed.

Parameter characteristic (continuous controller)

Parameter	Setting	Control and line-out of disturbances	Start-up behaviour
Xp1	higher	increased damping, slower line-out of disturbances	slower reduction of duty cycle (energy), possible overshoot of set-point
	lower	reduced damping, faster line-out of disturbances, increase Xp if process starts oscillating	faster reduction of duty cycle (energy), increase Xp, if line-out oscillates
Tn	higher	increased damping, slower line-out of disturbances	slower change of duty cycle (energy)
	lower	reduced damping, faster line-out of disturbances, if the stability becomes too low: increase Xp	faster change of duty cycle (energy)
Tv	higher	reduced damping, faster response to disturbances	earlier switch-off downscale of set-point, and slower line-out
	lower	increased damping, slower response to disturbances	late switch-off downscale of set-point with possible overshoot

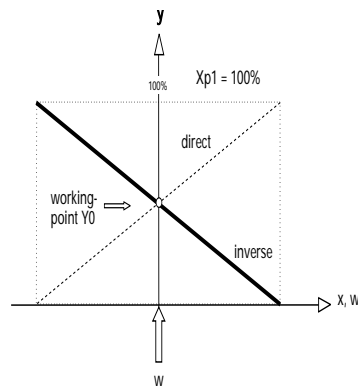

PD-behaviour ($T_n = 0$)

The working point is determined with $X=W$ output $Y = 50\% + Y_0$.

For keeping the process lined out, a certain amount of energy dependent of set-point is required. This results in a permanent offset, which will increase with higher values for X_{p1} .

DPID-behaviour ($T_n \geq 0$)

By means of the integral action, the process is lined out without permanent offset.

The static characteristics of the continuous controller is identical to the one of the two-point controller. The difference is that a linearly variable current / voltage signal instead of a linearly variable duty cycle is output.

16 Water cooling

KS 800 is equipped with a special control algorithm for water cooling which is activated if configured accordingly. This setting is possible separately for each channel.

The evaporation effect occurs only above defined temperatures. Water cooling below these temperatures can be disabled.

Disabling is only possible during automatic mode. Negative correcting variables entered in manual mode are effective also below the enable temperature.

With water cooling, the cooling effect is very strong due to the evaporation effect. For a finely dosed effect, a digital duty cycle converter which can output very short pulses is required. Moreover, the correcting variable output for cooling by the controller (0 ... -100%) must be reduced.

The duty cycle converter for water cooling outputs a constant switch-on pulse for cooling. The pulse duration is hardware-dependent (response time of magnetic valve) and is adjustable with parameter T_{on} . The min. switch-off pulse length is determined with parameter $T_{p_{min}}$.

The effective correcting variable is determined by the switch-on pulse-to-cycle ratio (sum of switch-on and switch-off pulse). The reduction of the controller correcting variable signal is determined by parameters T_{on} and $T_{p_{min}}$.

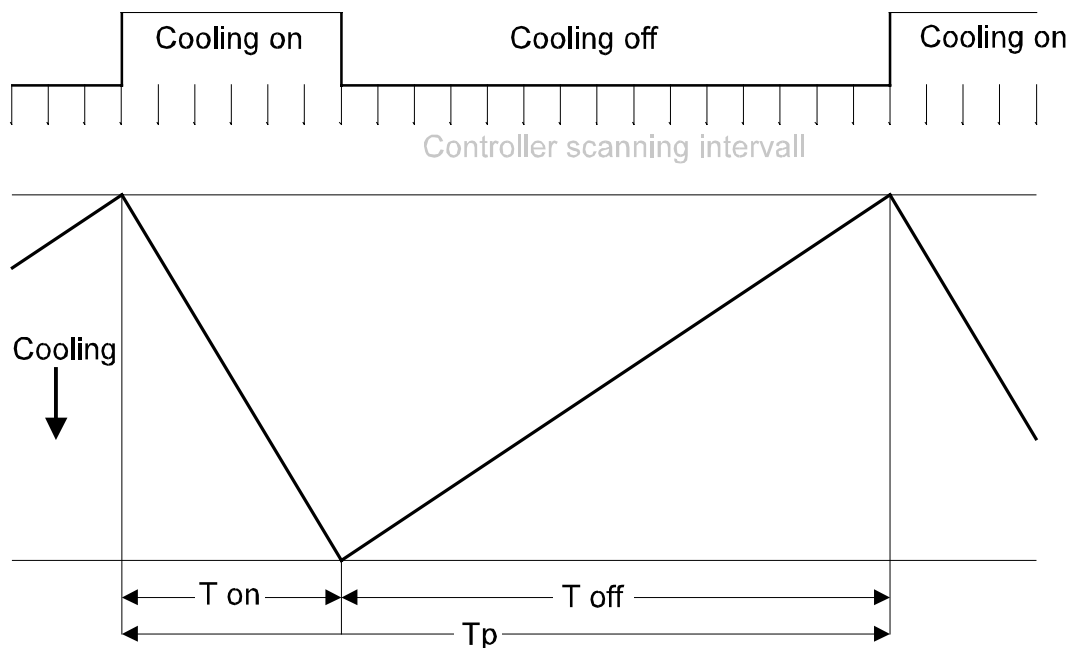

$$T_{Aus} [s] = K \frac{[s]}{[%]} \times (100 + Y_{Pid}) [%] \times \frac{(100 + Y_{Pid})[%]}{100 [%]} + T_{p_{Min}} [s] \quad \text{für } [-100\% < Y_{Pid} < 0\%]$$

$$T_{Aus} [s] = T_{p_{Min}} [s] \quad \text{für } [-100\% = Y_{Pid}] \quad \text{MIN.}$$

$$T_{Aus} [s] = (K \times 100 + T_{p_{Min}}) [s] \quad \text{für } [0\% = Y_{Pid}] \quad \text{MAX.}$$

Definitions:

T_{on} : Duration of cooling pulse (Parameter)
 BlueControl (TPuWk) The cooling pulse duration is constant. It is adjusted by parameter TPuWk (which is already provided).

The times can be changed only in multiples of the controller scanning interval (0,0625 s). With both operating modes, entered values are rounded to the next higher "scanning interval".

Entry "----" (FUNCTION_OFF) with water cooling is interpreted as TPuWk (0,0625 s). When reconfiguring controller functions setting TPuWk of which becomes invalid, TPuWk is set to "----".

T_{pmin} Switch-off time with $Y_{PID} = -100\%$ (Parameter)
 BlueControl (T2_0) For the min. pause time (T_{pmin}), parameter "min. cycle time 2" for 2/3-point controllers is used.

K Attenuation factor for pause time calculation. (Parameter)
 BlueControl (XshWk)

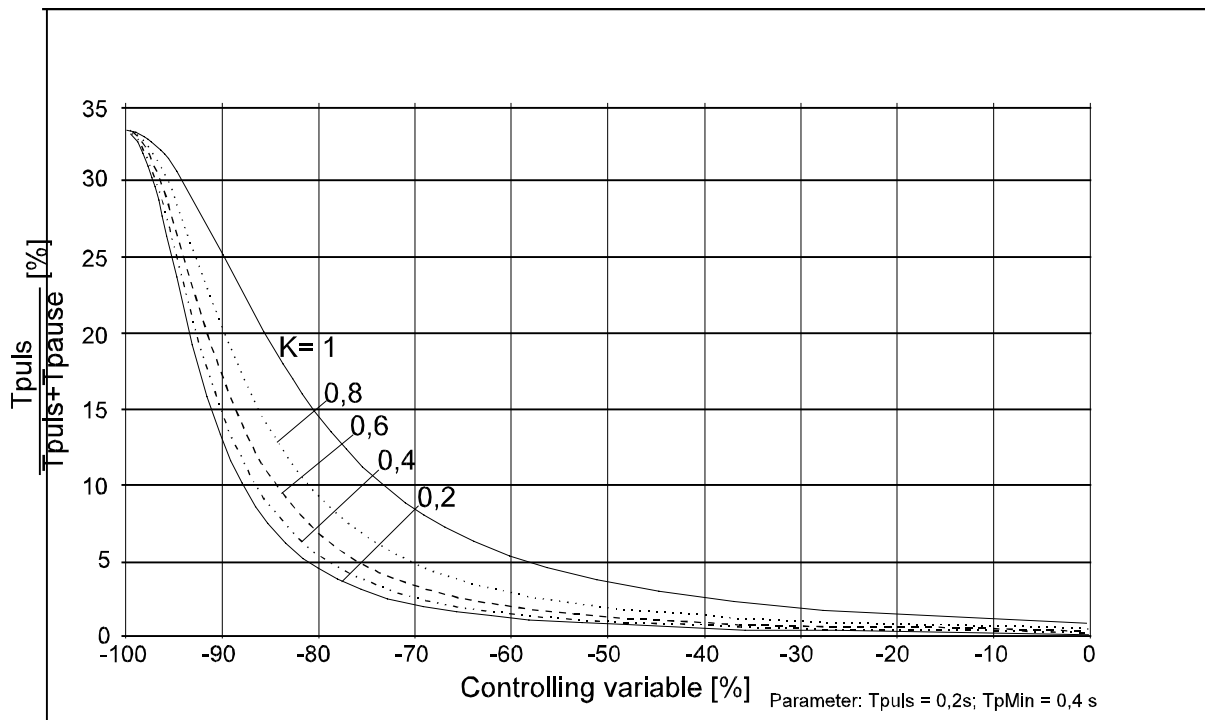

Y_{PID} Correcting variable (0...1), corresponds to 0%...-100%

T_{off} Switch-off pulse duration

T_p Cycle time (total of switch-on and switch-off time)

Y_{eff} Effective correcting variable at the output. As already mentioned, the max. output variable is limited with water cooling. With an internal correcting variable of -100%, it is $Y_{effmax} = T_{on} / (T_{on} + T_{off})$ dependent of adjusted duty cycle T_{on} .

Control parameters T_N and T_V for the cooling controller

There are important differences in the dynamic conditions for heating and cooling processes. Therefore, independent parameters for heating (X_{P1} , T_{N1} , T_{V1}) and cooling (X_{P2} , T_{N2} , T_{V2}) are determined during self-tuning with water cooling controllers. Switch-over is automatic when the correcting variable passes the zero with a hysteresis of 2% symmetrical to the zero.

Sequence control with set-point reduction

With a control deviation smaller than 5K after set-point reduction ($W_{new} < W_{old}$) and still negative (cooling) correcting variable, the correcting variable is set to "0", in order to avoid oscillation.

16.1 Water cooling controller self-tuning

Process-at-rest monitoring during self-tuning

The waiting time for process-at-rest monitoring at self-tuning start is increased from 90 s to 180 s for water cooling controllers.

Sequence of self-tuning with water cooling

When all (group) controllers signal "Process-at-rest", the cooling attempts can start. Unlike the other controller types which make parallel heating and cooling attempts, the attempts for water cooling are made successively because of the possible strong mutual effects. The water cooling controller with the smallest index will start. Only when this controller has finished the cooling attempt, the next controller will start. Adjacent controllers will not start in directly successive sequence, but in the order "odd controller number" -> "even controller number".

e.g. (with all 8 controllers configured for water cooling):

Contr. 1 \Rightarrow Contr. 3 \Rightarrow Contr. 5 \Rightarrow Contr. 7 \Rightarrow Contr. 2 \Rightarrow Contr. 4 \Rightarrow Contr. 6 \Rightarrow Contr. 8

17 Cascade control

For cascade control, one master and one or several slave controllers the set-point of which is the analog master control output are used.

As long as cascade control remains at two levels (1 master controller with 1 level slave controllers) any combination is possible: from 1 master with 7 slaves up to 4 masters with 4 slaves. Main configuration C100 determines, if a controller is a master or a slave. In configuration C180 (section 19.2.3), the external set-point source for the slave controller is specified for determination of the cascade structure. One master controller can provide the external set-point for several slaves.

Cascades over more than one unit are not possible.

17.1 Configuration of a simple cascade with one master and one slave

Each of the 8 controllers can be configured as a master or as a slave.

Configuration of **master controller**: C100_43 = 02 (2-pnt./master controller with output Ypid)
 C100_1 = 0 (set-point)
 C180_3 = 0 (no Wext)

Configuration of **slave controller**: C100_43 any
 C100_1 = 1 set-point / cascade)
 C180_3 = 1 - 8 (Wext = Ypid from master controller 1 - 8)

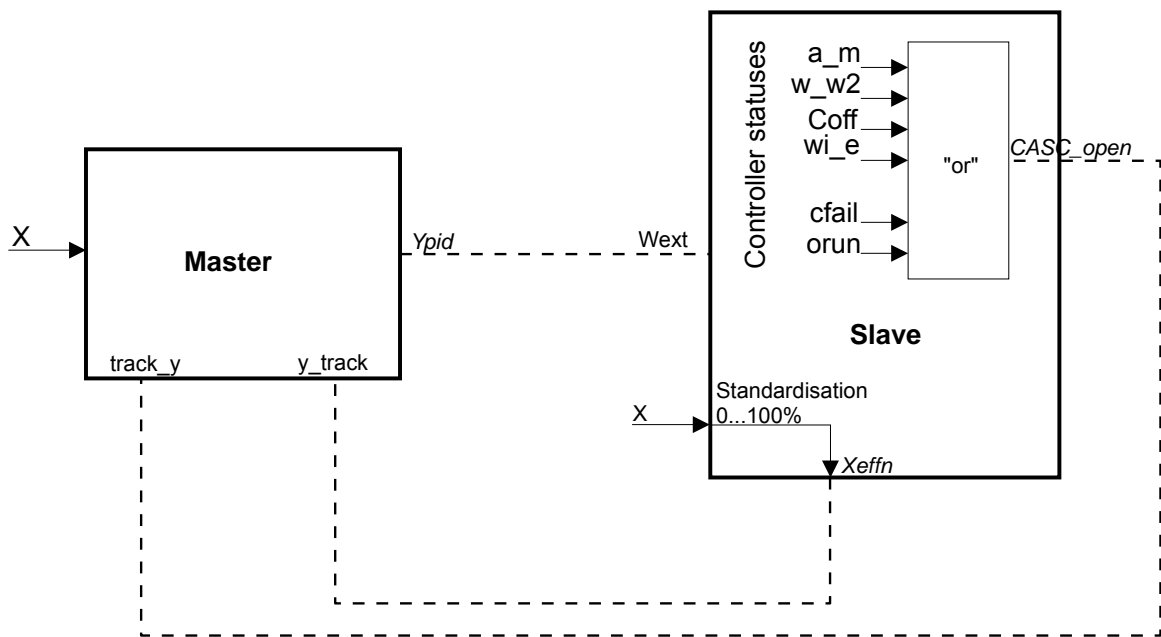

Single cascade controller

In the above example, 4 groups, each with one master and slave controller are possible. The controllers in a cascade are connected internally via configuration and communicate with each other. Additional scaling of the inputs and outputs is not necessary.

Special input signals of the cascade controller for cascade operation:

Wext: The master provides a continuous output signal Ypid in 0 ... 100%, which is connected with the internal Wext input of the cascade controller - as configured in C180.

xeffn: Process value input X of the cascade controller is standardized to 0 ... 100% and copied back to the master as output signal Xeffn, if the internal signal CASC_open is set (cascade is interrupted).

17.2 Controller behaviour with switch-over

17.2.1 Master controller switch-over from:

Automatic to manual = no effects on slave controller
W to W2 = no effects on slave controller
Outputs off = Ypid = 0, Wext of slave controller is also = 0, otherwise no effects.
Sensor break = Ypid upscale, downscale or neutral dependent of configuration.
Controller self-tuning start = Ypid is set to various values by the self-tuning.

17.2.2 Slave controller switch-over :

The following switch-overs set signal CASC_open internally to signal interruption of the cascade (CASC_open is not accessible externally):

- automatic to manual
- W to W2
- outputs off
- sensor break
- Wext to Wint (via interface)
- Controller self-tuning start

17.3 Interruption of cascade operation

The master controller evaluates the slave controller status at every cycle. With cascade interruption, the master controller changes internally from automatic to manual. For this purpose, the process value standardized by the slave controller is used for continuous adjustment Yhand of the master and output to Ypid. Thereby, saturation effects of the master in the open cascade are avoided. Adjustment of the manual value is not possible in this mode. When re-closing the cascade by slave return to the initial mode, the master changes bumplessly from manual to automatic mode, if the master was in automatic mode before opening the cascade.

17.4 Example of cascade control with up to 7 slave controllers

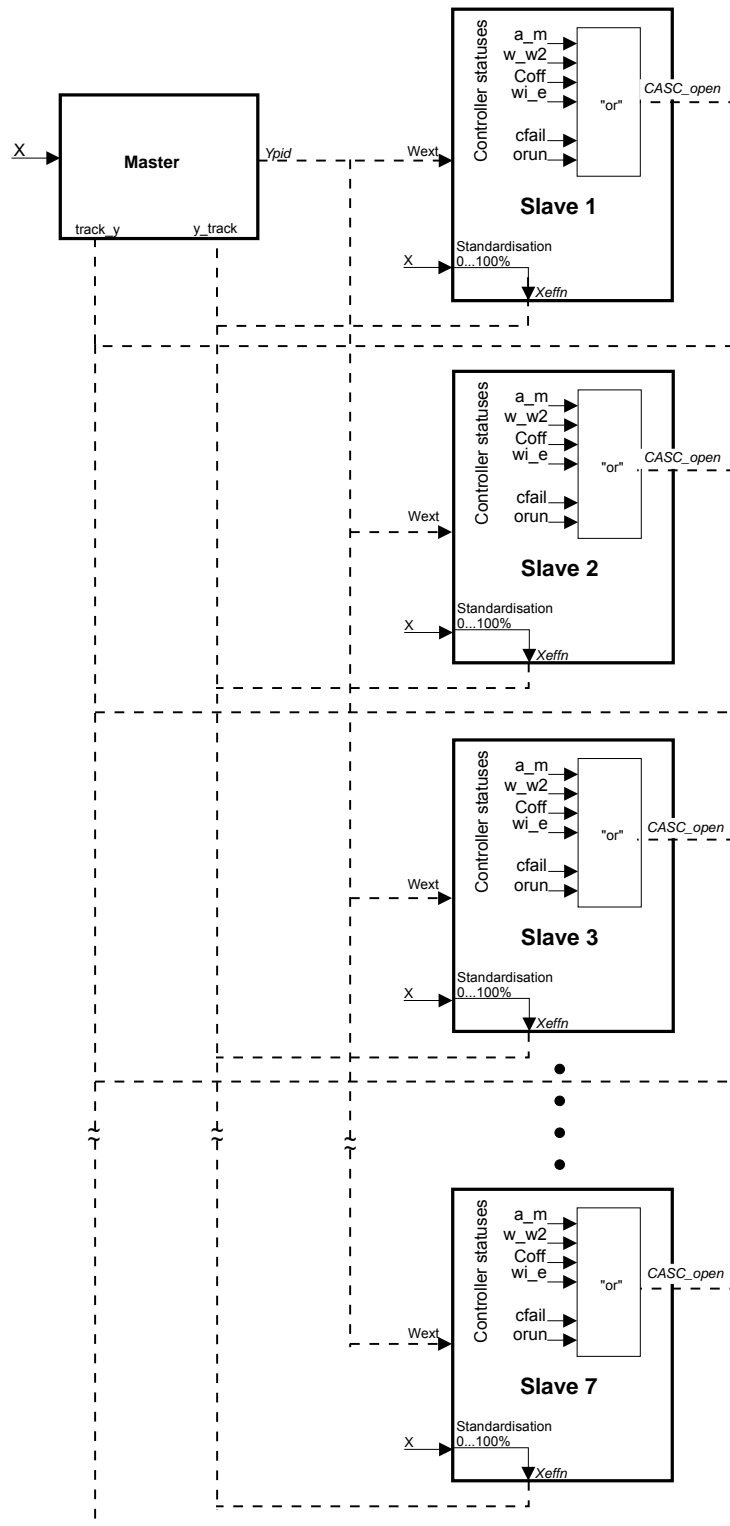

Cascade control with 7 slaves

For special applications, connecting up to 7 slave controllers to a master controller is possible. In this case, the correcting variable of the master is used as set-point for the slaves. These controllers control the connected loop individually with their adjusted parameters.

Configuration of the master controller:

C100_43	= 02	(master with output Ypid)
C100_1	= 0	(set-point)
C180_3	= 0	(no Wext)

Configuration of slaves:

C100_43	= any	
C100_1	= 1	(set-point / cascade)
C101_2	= 5	(last mean Y)
C180_3	= x	(Wext = Ypid from master channel x=1-8)

The operating principle is as described for simple cascade control.

However, when switching over a slave controller, or with cascade interruption, note that:

When the cascade is opened due to any slave event, the process value standardized by the slave is used for master Yhand adjustment and output to Ypid. This concerns all connected slave controllers. When several slaves are in this status simultaneously, adjustment is to the value which was copied into the master input by the last concerned slave.

18 Start-up circuit

The start-up function is a controller function and must be specified for each individual controller by configuration C101_1 = 1 (with start-up circuit). The start-up function only remains active if the controller runs in automatic mode; any other mode causes cancellation of the start-up function.

Abbr.	Description	Range	Default
Ya	Max. correcting value	5...100%	5%
Wa	Start-up set-point	-999...9999	95
TPa	Start-up holding time	0...9999 min	10 min

After controller switch-on with $X < Wa < W$, correcting variable Y is limited to Ya . Thereby, the process values runs towards set-point Wa with constant $Y = Ya$. The start-up holding time TPa starts 1K below this value. After elapse of this time, the process is lined out to set-point W . If the process value $> LCA$ (40K, fixed) falls below set-point Wa due to a disturbance, the procedure starts again. With $W < Wa$, W is used as start-up set-point without holding time.

Self-tuning start does not lead to cancellation of the start-up circuit. The optimization runs with a particular start-up circuit status. When starting the optimization from status ANFAHR_LIMIT_Y, a limited correcting variable is used. When starting from another status, the correcting variable is not limited. After optimization end, the start-up circuit starts in one of the other statuses dependent of condition.

The following start-up circuit statuses are possible

ANFAHR_OFF:	Normal control mode with line-out to W
ANFAHR_LIMIT_Y:	Control with start-up set-point, correcting variable effective, cycle time $T01/4 > 0.4$ sec
ANFAHR_HALTEZEIT:	Control with start-up set-point for the duration of the holding time
ANFAHR_TUNE:	Optimization running

ANFAHR_OFF status

If the process value falls by more than 40K below the active start-up set-point (Wa), the start-up circuit switches to the ANFAHR_LIMIT_Y status. The start-up function is handled again.

ANFAHR_LIMIT_Y status

The controller is operated with max. correcting variable limit $Y = Ya$. A lower controller correcting variable has priority. Moreover, the min. cycle time is reduced to $\frac{1}{4}$ of the adjusted cycle time.

With the process value less than 1K below the active start-up set-point Wa and $Wa < W$, the start-up circuit switches to the ANFAHR_HALTEZEIT status. Start-up holding time start.

With the process value less than 1K below the active start-up set-point Wa and $Wa > W$, the holding time is omitted and the start-up circuit is switched over to the ANFAHR_OFF status. (line-out to set-point W in normal mode).

ANFAHR_HALTETZEIT status

When the process value falls by $> LCA$ (40K, fixed), the start-up circuit switches to the ANFAHR_LIMIT_Y status. When the set-point for normal mode (W) falls below the requested start-up set-point (W_a), the holding time is cancelled and the start-up circuit switches to the ANFAHR_OFF status.

With the requested holding time PT_a elapsed, the start-up circuit is finished and switched over to the ANFAHR_OFF status.

ANFAHR_TUNE status

With self-tuning finished, the controller is switched over to another status according to the actual condition.

When the actual process value is above the actual start-up set-point, the controller is switched over to the ANFAHR_OFF status.

With a control deviation $< 1K$ and a start-up set-point (W_a) $<$ actual set-point (W), the controller is switched over to the ANFAHR_HALTETZEIT status.

With a control deviation $< 1K$ and a start-up set-point (W_a) $>$ actual set-point (W), the holding time is omitted and the controller is switched over to the ANFAHR_OFF status.

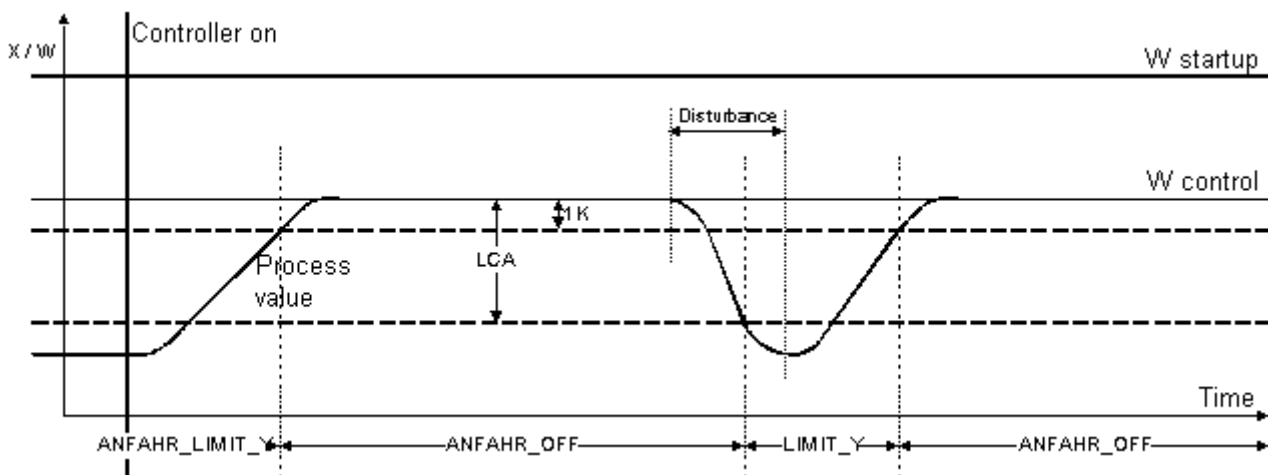
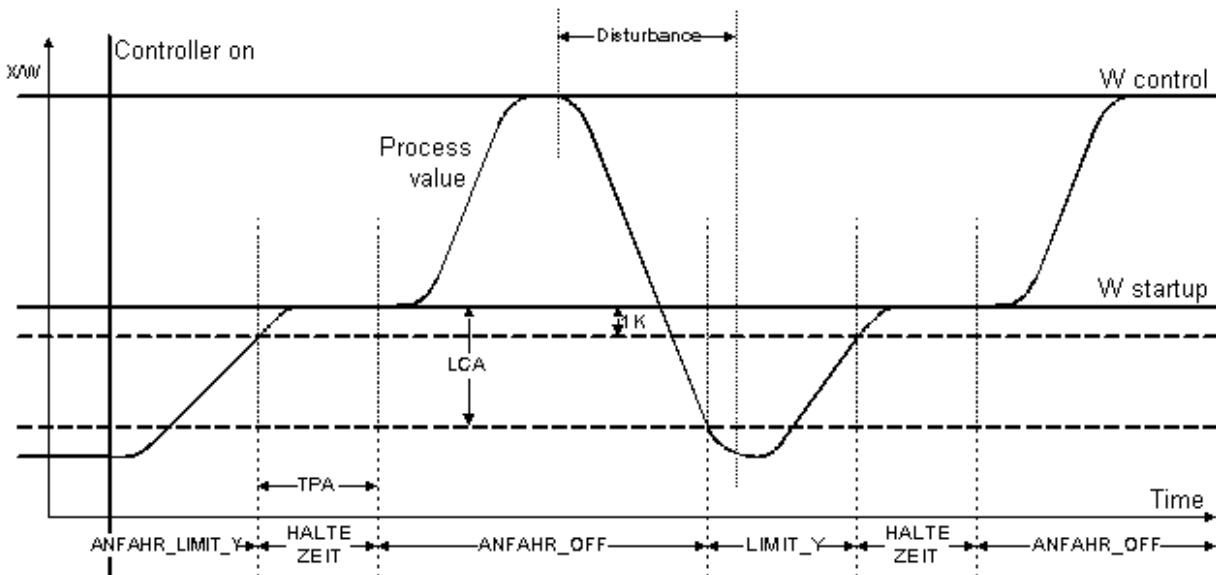

19 Mean value formation for the output hold function

Mean value formation is only effective for configuration with C101_2 = 5.
The parameters required for this purpose are transferred from:

Mean value formation is a controller function and must be specified for each individual controller by configuration C101_2. In case of sensor failure, an average value is output and the controller switches over to a kind of "manual mode", in which manual adjustment of the correcting variable is possible. After removal of the sensor failure, return to the automatic mode is automatic.

Function block controller type no.:91, function Correcting variable, function number 4.

Abbr.	Description	Range	Default
Yh	Max. mean value of output	5...100 %	5,0 %
LYh	Limit for mean value formation	0,1....10,0	1,0

Mean value calculation

With the control deviation within LYh (limit for mean value formation), the arithmetic mean value from mean and new controller correcting variable is calculated.

$$\text{Mean value} = (\text{mean value} + \text{new correcting variable}) / 2.$$

With the control deviation value smaller than the requested limit value (LYh) during min. 60 sec and the limits of Yh, Ymax. and Ymin met, the mean value is output as correcting variable. Manual adjustment is possible.

Inverse / direct controller mode

Configuration C101_4 determines, in which way the controller processes the control deviation $xw = x-w$. During "inverse operation", the correcting variable decreases, when the control deviation is positive. The process value is higher than the effective set-point.
During "direct operation", the correcting variable increases, when the control deviation becomes positive. The process value is higher than the effective set-point.

X/XW differentiation

Configuration C101_3 determines how to differentiate the control variable or the control deviation.

With C101_3 = 0, the control deviation is differentiated.

With C101_3 = 1, process value X is differentiated dx/dt .

20 Heating current monitoring

20.1 Heating current monitoring

The **heating current monitor** is limited to controller outputs 1...8 and provides monitoring for heating circuit undercurrent and actuator short circuit.

Monitoring can be done at an adjustable cycle:

All controllers except the one to be monitored are switched off (independent of control) and the heating current is measured. It must be higher than the value specified in LimHC, otherwise an undercurrent error message is output.

After elapse of the (adjustable) cycle time, the next controller is checked with the same procedure, etc.

After completing the overall cycle once with all controllers configured accordingly, all controllers are switched off. The current must be lower than 3% of HC100. Otherwise, an actuator is short-circuited. In this case, the individual test is done with the quickest possible cycle time of 2,25 s: all heating loops except the one to be checked are switched off. Unless the measured current increases as compared to the short circuit current determined previously, there is a short-circuit at the tested switching element.

After the complete short circuit test, a new heating current monitoring cycle is started with controller 1 and the cycle time adjusted in the configuration. As all currents to be monitored are looped through the same converter, the heating currents of all other heating loops are displayed with an error in such an error case: the value is too high by the short circuit current amount. (The circuit with the short circuit in the switching element cannot be switched off.)

After elapse of the cycle time, the next controller (2) in the cycle is subjected to this procedure, etc.

Evaluation is controller-specific and must be adjusted for each controller.

The main controller configuration C150 (once per controller) determines, if the monitoring function is or is not active.

C150 = 0 no monitoring for heating current and outputs for the overall unit.

C150 = 1...99 factor heating current monitoring and output monitoring are provided.

See also next section !

In the additional heating current configuration C151, specification for which output (OUT17...OUT19) the evaluated alarm shall be output is required for each controller.

C151_3 Leakage current alarm default 0 = no output

C151_4 Heating current alarm default 0 = no output

20.2 Monitoring cycle

The monitoring cycle can be adjusted as follows:

$$\text{Monitoring cycle [sec]} = 2,25 \text{ [sec]} \times \text{factor}$$

This value is the time between two controller checks. Duration of a complete instrument check:

$$\text{Number of controllers} \times \text{cycle time} + 1 \text{ cycle (short-circuit monitoring)} = \text{overall time}$$

The factor can be adjusted within 0 and 99, whereby 0 = no check.

With an entry within 1 and 90, each controller is scanned at this interval, whereby the actual scanning time is 3 controller output cycles of 63 ms each; 2ms are the measurement time (se-

ting) and the measured value is transmitted in the 3. cycle.

For electromechanical switching elements, the measurement time must be extended considering the inertia. This is by entry a "8" in the hundreds position (e.g. 854). The cycle time remains unchanged. Only the measurement time is extended to 10 output cycles: 9 cycles are for the measurement time and setting: Transmission of the measured value is in the 10. cycle.

In heating current configuration C151, specification to which output (OUT17...OUT19) the evaluated alarm shall be output is required.

Control operation can be disturbed by controller switch-off (during control operation). For keeping this effect low, monitoring should not be carried out too frequently.

20.2.1 Heating current alarm, reset and quick test

Via the bus interface, all heating current alarms for the current cycle can be reset by means of an input signal. If the heating current alarm is still present during the next test cycle, the alarm is triggered again.

Moreover, a quick-test is possible: all channels are tested for heating current limit value, switching element short circuit and leakage current (if a corresponding external instrument is connected) at the shortest possible cycle time (2,25 s).

Furthermore, a combination of reset and quick testing is also possible. At first, all heating current alarms are reset. Subsequently, quick testing is done starting with channel 1 (cycle time 2,25 s).

Function block Instrument type no.: 0, function HC_reset, function number 0.

Name	Description	Range	Default
HC_reset	Heating current reset/quick test	0...3	0

HC_reset	=	0	normal operation (using the data defined by the manufacturer)
	=	1	reset of all heating current alarms
	=	2	realization of quick testing
	=	3	reset of all heating current alarms with subsequent quick test of all channels

After handling of the selected software routine, the HC_reset is reset to 0 automatically.

21 Evaluation of heating current measurement

The measuring range of the heating current input is 30mA AC for direct connection to standard current transformers. Below HC100, specification which current (in A) actually flows when the current transformer delivers 30mA AC is required.

The parameters required for heating current measurement are transferred instrument-specifically from:

Function block instrument type no.: 0, function I/O connection, function number 2.

Abbr.	Description	Range	Default
HC100	Span end for HC	1....9999 A	30,0 A

The heating current monitor responds, when:

1. a heating current flows although the controller has switched off (actuator short circuit).
2. the controller has switched on and the current is below the value specified in LimHC (heating circuit undercurrent).

The heating current limit value is transmitted controller-specifically from:

Function block alarm type no.:46, function General, function number 0.

Abbr.	Description	Value range	Default
LimHC	Heating current limit value for HC	0...HC100	-32000

For switching off the evaluation of an individual controller, LimHC must be adjusted to -32000. With the heating current monitoring switched off, error current monitoring is also omitted.

21.1 Leakage current monitoring

Leakage current monitoring is done in parallel to heating current monitoring with an external difference current relay the response delay of which must be ≤ 60 ms. The evaluation is provided to the controller by digital input IN/OUT15.

In configuration C500_2, the leakage current monitoring input must be adjusted (default).

The leakage current monitoring can be switched off for individual controllers by

1. switching off the heating current monitor, or
2. not looping the heating cables through the current relay.

21.2 Heating current scaling factor

A scaling factor is applicable to all converters in conjunction with KS 800.

The KS 800 heating current input was initially designed for a converter with a transmission ratio of 1:1000, at a max. primary current of 30A, i.e. $I_{\text{sek}} = 30\text{mA}$.

Without changing, the scaling factor is 1, since the converter provides a secondary current of 30 mA with a primary current of 30A. (In this case, 30 (A) is displayed.)

With other converters, a scaling factor must be determined and taken into account when calculating the HC100 value of KS 800.

Using the same conversion factor for all converters is not possible, since this factor is dependent of various technical properties of the two instruments (transmission ratio of the converter, its internal resistance, internal converter rectification, if applicable). Due to these different "converter data" and the KS800 input data, various scaling factors must be determined empirically.

For the active PMA converter (order no. 9404 829 10223), a scaling factor of 2,60 is applicable. In the KS 800 engineering (HC100), this factor must be taken into account for correspondence of display and heating current.

E.g. the heating current is 3 x 18A. The entry in HC100 must be $30 \times 2,6 = 78$ (A), for a subsequent display of value 54 (A). (Without scaling, 20,8 (A) would be displayed.)

or:

$$I_{\text{prim}} = 135\text{A} (3 \times 45\text{A})$$

Display with default scaling : 52,22 (A)

Display with special scaling : 134,5 (A)

Note:

The entry in HC100 is not a scaling in the sense of a measuring instrument, whereby a **higher** scaling means a **smaller** display value.

With KS 800, standardization relates to the controller input current: with an input current of 30mA, 30 (A) is displayed. For allocating a higher display to the same input current, however, the HC100 value must be increased.

22 Alarm handling

For each controller, four alarm trigger points can be adjusted independently (without determination of names and abbreviations!). However, using the expressions used in the drawing is purposeful.

The switching hysteresis is equal for all four trigger points.

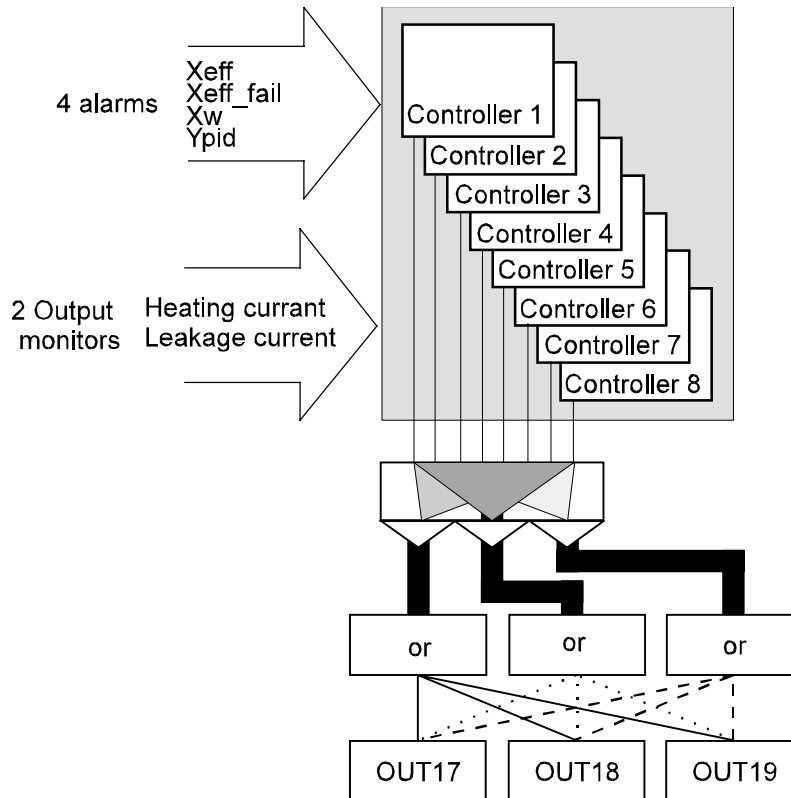

Various sources which can be monitored with up to four values can be used as alarm signal source for each controller. Only one alarm source per controller can be monitored, distribution of the four trigger points to several alarm sources is not possible.

Sources for the alarms can be:

Xeff	The effective process value (the control variable) as a relative or absolute alarm.
Xeff_fail	A sensor circuit failure, sensor break or short circuit.
Xw	Control deviation alarm, the control deviation has exceeded a defined value.
Ypid	Correcting variable alarm, when the correcting variable leaves the defined range.

Hardware grouping of the individual controller alarms is into common alarms, software detection is individual via the interface.

Alarm outputs OUT17, OUT18 and OUT19 are preceded each by an OR function, which provides the alarm signals of the individual controllers as a "common" alarm to one of the outputs.

The resulting restriction is: if an (external hardware) reaction must be triggered directly by an alarm, only similar alarms may be grouped.

Like the other controller outputs, these alarm outputs are galvanically isolated from the remaining electronics, but mutually connected via a common plus.

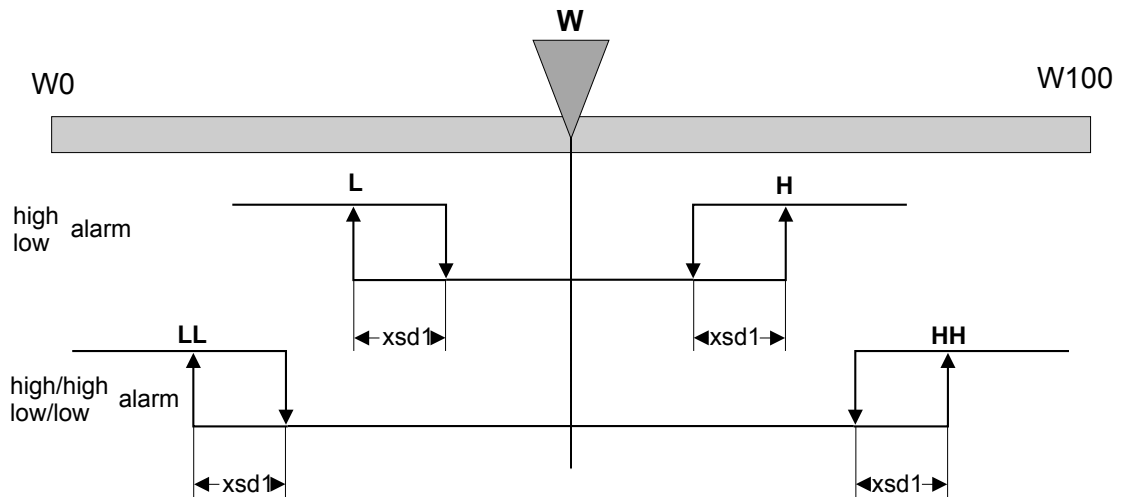

Configuration word C600 and C601 determines which signal shall be monitored by the alarm function and how the alarm functions are used.

Function block alarm type no.:46, function General, function number 0.

Abbr.	Description	Range	Default
LimL	Low alarm	-999...9999	-32000
LimH	High alarm	-999...9999	-32000
LimLL	Low low alarm	-999...9999	-32000
LimHH	High high alarm	-999...9999	-32000
Xsd	Alarm switching differential	0...9999	0,5

23 Configuration

23.1 General

The KS800 controller configuration is described in this section. In the configuration, the function required for an application are selected from a variety of functions. By configuration, the basic structure for an application solution is determined. Digits which cannot be selected are marked by an "0".

23.2 Main configuration groups

Main configuration groups are:

	Description	Configuration word ranges
1	Controller function	C100 ... C151
2	Input function	C180 ... C499
3	Output function	C500 ... C599
4	Alarm funktion	C600 ... C699
5	Controller self-tuning	C700 ... C799
6	Additional functions	C900 ... C999

23.2.1 C100 main controller configuration (adjustable per controller)

This main group determines the controller structure and function and is the starting point of controller configuration for a specific application. Main configuration is with configuration word C100. After determination of this word, no further settings are required for a large number of applications. Additional function determinations are possible via configuration word C105.

	C100			
Digit	4	3	2	1
Description	CFunc			WFunc
Default	02		0	0
Determination	always			

- CFunc:** (Controller Function, control behaviour)
- 00: Signaller 1 output
 - 01: Signaller 2 outputs
 - 02: 2-point contr. (or master controller with output Ypid slave contr. setpoint)
 - 03: 3-point controller (heating switching / cooling switching)
 - 04: 3-point controller (heating continuous / cooling switching)
 - 05: 3-point controller (heating switching and cooling continuous)
 - 07: 3-point stepping controller
 - 10: Continuous controller
 - 11: Split-range controller heating continuous / cooling continuous)
 - 12: 3-point controller water-cooling
 - 13: Limiter with holding function

- CType:** (Contr. type) special function, normally not required
- 0: Standard control (no mean value formation)
 - 4: Mean value with the (one) next higher number
 - 5: Mean value with the two controllers with the next higher values

Wfunc:	(set-point function)
0:	Set-point $W_{\text{eff}} = W_{\text{int}}/W2$
1:	Set-point/cascade $W_{\text{eff}} = W_{\text{int}}/W_{\text{ext}}$ (with slave controller: $W_{\text{ext}} = Y$ from master controller)

23.2.1.1 C101 additional controller configuration (adjustable per controller)

The following additional adjustments are possible via the additional controller configuration:

	C101			
Digits	4	3	2	1
Description	CMode	CDiff	CFail	CAnf
Default	0	1	1	0
Determination	always			

CMode: (Controller action)

- 0: Inverse increasing input signal generates decreasing output signal
 1: Direct increasing input signal generates increasing output signal

CDiff: (differentiation)

- 0: Xw differentiation control deviation differentiation
 1: X differentiation process value differentiation

CFail: (controller behaviour with main variable sensor failure)

- 0: Neutral (controller outputs switched off as in de-energized condition)
- 1: Ypid = Ymin The correcting variable is set to the min. value. ¹⁾
 2: Ypid = Ymax The correcting variable is set to the max. value. ¹⁾
 5: Ypid = Ymit Output of the calculated mean correcting variable. Simultaneous switch-over to manual operation, the correcting variable can be changed manually.

(Ypid is the actual controller correcting variable)

- 6: **no fail behaviour** No reaction to sensor failure. The controller does not react to input sensor failure. The configured substitute input value (Xfail from C213) is always used as measurement value. Thereby, it is unimportant whether the input measurement is in failure condition.

CAnf: (start-up circuit)

- 0: no start-up circuit
 1: with start-up circuit

¹⁾ Ymin and Ymax are determined separately for each controller in **function block controller type no. 91, function Correcting variable, function number 4.**

23.2.2 Control loop monitoring (loop alarm) (adjustable individually for each controller)

Control loop monitoring can be activated individually for each controller.

Hereby, the overall control loop comprising sensor, controller, switching element, (power) fuse, heating or cooling and all leads is monitored.

The monitoring principle is that the process value must increase with an output of 100%: during a time of $2 \cdot T_{n1}$, the process value must change by min. 1% of the span of the configured sensor type. As this method works with the integral time (T_n), it can be used only for controllers with I-action (99,5% of all applications).

Virtually all errors possible in a control circuit are monitored:

- Sensor short circuit,
- Sensor polarity error,
- Sensor without thermal contact with the relevant heating,
- Sensor break (monitored additionally by the sensor alarm),
- Lead break,
- Failure of the controller (not of the alarm facility),
- Failure of the switching element,
- Failure of fuse or (power) energy.

Once switched on, monitoring is always active:

Control loop o.k.:

Starting the cold machine: duty cycle = 100% -> the temperature increases;
Temperature reached -> duty cycle <100% -> monitoring is inactive;
set-point increase -> X-W increases -> duty cycle = 100% -> temperature increases.

Error in the control loop:

With an error anywhere in the control loop, the temperature decreases despite an increase of the control deviation (X_w) and thus of the output variable Y_{pid} . When Y_{pid} is 100%, measurement if the temperature changes in the required direction during $2 \cdot T_{n1}$ is done. Unless this is the case, a control loop alarm is triggered. Alarm signalling is at the earliest with a delay of $2 \cdot T_n$. The above mentioned example relates to inverse controllers (heating); it is applicable analogously to direct controllers (cooling).

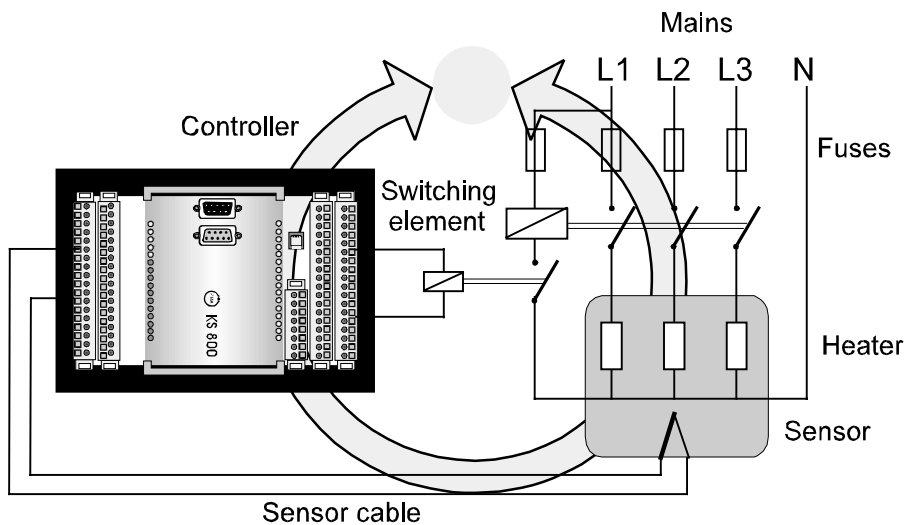

Closed loop monitoring (Loop-Alarm)

Control loop monitoring is controlled via configuration word C102:

	C102			
Digit	4	3	2	1
Description				LoopOn
Default	0	0	0	0
Definition	always			

LoopOn: control loop monitoring

0: off
1: on

23.2.3 C150 Heating current and output monitoring and additional configuration C151 (adjustable for each unit)

Adjustment of cycle time for heating current, leakage current and output monitoring (adjustable for each unit)

The **heating current monitor** provides monitoring for undercurrent of the heating element (measured heating current value < LimHC) and actuator short circuit (measured heating current value > 3% HC100). In the individual controller statuses, the actual current is measured and evaluated. Evaluation is controller-specific and must be adjusted separately for each controller. Heating current measurement is HCzykl-dependent.

Leakage current monitoring is the failure alarm evaluation (configuration C500_2).

Output monitoring is the digital output evaluation.

	C150			
Digit	4	3	2	1
Description	HCzykl			
Default	0			
Determination				

HCzykl: (factor for the cycle time)
0: no monitoring for heating current, leakage current and output in the overall unit
1 ... 99: factor

Heating current monitoring switch-off per controller is possible via parameter "Lim_HC". In this case, the relevant output is not switched on for heating current monitoring, but switched off with short circuit to permit output monitoring.

Note that all controller outputs are switched off cyclically with the heating current monitor activated (HCzykl > 0), which can affect control. The measurement frequency is affected by the factor.

Note concerning the factor: The factor determines the cycle between the checks of 2 channels.

23.2.3.1 C151 additional heating current configuration (adjustable for each unit)

The additional heating current configuration determines the output of the heating current statuses to the alarm output.

	C151			
Digits	4	3	2	1
Description	DestHC	DestLeck	DestOuterror	
Default	0	0	0	0
Determination	always			

- | | | | |
|----------------|-----------------------|------------------|--------------------------------------|
| DestHC: | (target for HC alarm) | DestLeck: | (target for a failure current alarm) |
| 0: | no output | 0: | no output |
| 1: | output to OUT17 | 1: | output to OUT17 |
| 2: | output to OUT18 | 2: | output to OUT18 |
| 3: | output to OUT19 | 3: | output to OUT19 |

- DestOuterror:** (target for output monitoring alarm)
- 0: no output
 - 1: output to OUT17
 - 2: output to OUT18
 - 3: output to OUT19

23.2.4 C180 analog signal allocation

Control signals for set-point processing (adjustable for each controller)

	C180			
Digits	4	3	2	1
Description	SWext			
Default	00		0	0
Determination	always			

SWext: (source for the external slave controller set-point)

- | | | |
|--------------------------------------|--|--|
| 0: no Wext | | 41: Wext = Y2 from master controller 1 |
| 1: Wext = Y from master controller 1 | 42: Wext = Y2 from master controller 2 | |
| 2: Wext = Y from master controller 2 | 43: Wext = Y2 from master controller 3 | |
| 3: Wext = Y from master controller 3 | 44: Wext = Y2 from master controller 4 | |
| 4: Wext = Y from master controller 4 | 45: Wext = Y2 from master controller 5 | |
| 5: Wext = Y from master controller 5 | 46: Wext = Y2 from master controller 6 | |
| 6: Wext = Y from master controller 6 | 47: Wext = Y2 from master controller 7 | |
| 7: Wext = Y from master controller 7 | 48: Wext = Y2 from master controller 8 | |
| 8: Wext = Y from master controller 8 | | |

23.2.5 C190 digital signal allocation

Control signals for set-point processing (adjustable for each controller)

	C190			
Digits	4	3	2	1
Description			SCoff	Sw/W2
Default	0	0	0	0
Determination	always			

SCoff: (switch off controller outputs of control function)

- 0: controller can only be switched off via the interface separately for each individual controller
- 1: controller can be switched off via control input IN/OUT14¹⁾ and via interface ²⁾
(0=on, 1=off)
- 2: Controller switched off continuously, enabled for heating and cooling output forcing
- 3: Inverse Function of 1 via IN/OUT14 ¹⁾ **(0=off, 1=on)**

Sw/W2: (source for W/W2 switch-over)

- 0: W/W2 can only be switched over via the interface, separately for each controller
- 1: W/W2 can be switched off via control input INOUT16¹⁾ and via interface ²⁾

¹⁾ one control input for all controllers configured accordingly (control input configuration in C500.)

²⁾ each controller can be switched individually via the interface.

23.3 Inputs

In this main group, the signal inputs for the selected controller configuration are determined. Like with the control function configuration, a large number of applications can be covered by determination of the main configuration.

Signal input 1/IN1...IN8 (main variable)

Used for configuration of the main variable. These signal inputs are universal inputs and can be configured extensively.

23.3.1 C200 main configuration

The main configuration word determines sensor type and physical unit (adjustable for each controller). If necessary, additional input configurations are possible with additional configuration C201 to 214.

	C200			
Digits	4	3	2	1
Description	Type		Unit	
Default	02		1	0
Determinatio	always			

Type: (sensor type)

thermocouple:

00:	type L	0 ... 900 °C
01:	type J	0 ... 900 °C
02:	type K	0 ... 1350 °C
03:	type N	0 ... 1300 °C
04:	type S	0 ... 1760 °C
05:	type R	0 ... 1760 °C
06:	type T	0 ... 400 °C
07:	type W	0 ... 2300 °C
08:	type E	0 ... 1000 °C

Resistance thermometer:

20:	Pt 100	-99,9 ... 850,0 °C
-----	--------	--------------------

Voltage:

34:	-100 ... +100 mV
-----	------------------

Resistance:

40:	0 ... 400 Ω
-----	-------------

Unit: (Unit)

0:	fixed with type = 34
1:	°C
2:	°F

23.3.2 Input scaling

Input scaling is only possible with DC voltage input. With input scaling, different physical quantities are allocated to the electrical input voltages for (span) start and end.

(e.g. 0mV Δ 0l/h and 80mV Δ 1000l/h; 0mV Δ -500mbar and +100mV Δ 500mbar)

Scaling must be done separately for each controller.

23.3.2.1 C201 input scaling start

Adjustment of the span start value X0

	C201			
Digits	4	3	2	1
Description	X0			
Default	0			
Determination	only with type = 34			

X0: (physical value at 0%)
numeric value -999 ... 9999

23.3.2.2 C202 input scaling end

Adjustment of span end value X100.

	C202			
Digits	4	3	2	1
Description	X100			
Default	100			
Determination	only with type = 34			

X100: (physical quantity at 100%)
numeric value -999...9999

23.3.3 C205 additional configuration

Via the additional configuration (for the inputs), the default setting for the signal input can be changed or matched dependent of sensor type (adjustable for each controller).

	C205			
Digits	4	3	2	1
Description	Fail	STk	XKorr	reserve
Default	1	1	0	0
Determination	always	only when type=00...08 (C200)	always	fixed

- Fail:** (signal behaviour with sensor failure)
 1: Upscale (signal is set to a high value)
 2: Downscale (signal is set to a low value)
 3: substitute value (substitute value determined in C213)

- STk:** (type of temperature compensation)
 0: not effective
 1: internal TC
 2: external TC (temp. value of TC is fixed in C210!)
 3: controller 8 TC Remote measurement of a cold-junction reference. Input 8 can be used so that it operates as input of the temperature sensor of a remote cold junction reference. The thermocouples of the individual measurement points are connected to a common cold junction reference by means of compensating lead. Between reference and KS800, copper lead can be used. The 8th input is used for measuring the temperature of this cold junction reference and for correcting the input voltage accordingly. If the sensor of controller 8 is a thermocouple, compensating lead must be used up to KS 800. If the sensor is a resistance thermometer, copper lead can be used. For accuracy, resistance thermometers should be connected in 3-wire circuit for this controller.

- Xkorr:** (enable process value correction)
 0: not effective
 1: with process value correction (adjustable via parameters x1in, x1out, x2in, x2out)

23.3.3.1 C210 external temperature compensation

	C210			
Digits	4	3	2	1
Description	Tkref			
Default	0			
Determination	only with type = 00...08 (C200) and Tk = 2 (C205)			

- Tkref:** (external TC)
 Numeric value: -99...100 °C or °F

23.3.3.2 C213 sensor failure

	C213			
Digits	4	3	2	1
Description	XFail			
Default	0			
Determination	only with Fail = 3 (C205)			

XFail: (substitute value with sensor failure)
 Numeric value: -999 ... 9999

23.3.3.3 C214 filter time constant

	C214			
Digits	4	3	2	1
Description	Tfm			
Default	0.5			
Determination	always			

Tfm: filter time constant of measurement value processing)
 Numeric value: 0...999,9 sec

23.4 Configuration examples

23.4.1 Thermocouples

With a thermocouple, the type of temperature compensation, the TC value and the signal behaviour with sensor break can be determined. The behaviour is determined with configuration word C205.

Configuration of:
C200, C205, C210, C213, C214

23.4.2 Resistance thermometer

With a resistance thermometer, configuration word C205 can be used for determination of the signal behaviour in case of sensor break/short circuit.

Configuration of:
C200, C205, C213, C214

23.4.3 Voltage

With a voltage input, configuration word C205 can be used to determine the signal behaviour with lead break. Additionally, configuration words C201 and C202 can be used for physical input signal scaling by specification of X0 and X100.

Configuration of:
C200, C201, C202, C205, C213, C214

23.4.4 C302 heating current input

The measuring range for heating current monitoring is determined in this configuration word (adjustable for each unit).

	C302			
Digits	4	3	2	1
Description	HC100			
Default	30			
Determination	always			

HC100: (physical value at 100%)
Numeric value: 1...9999 HC100 must be used to specify which current (in A) flows actually, when the current transformer delivers 30mA.

23.5 Outputs

23.5.1 C500 signal inputs/outputs IN/OUT13...IN/OUT16

Input/outputs IN/OUT13 ... IN/OUT16 are configured in this configuration word. They are designed bi-directionally and can be configured as inputs and as outputs (adjustable for each unit).

	C500			
Digits	4	3	2	1
Description	Fkt_dio1	Fkt_dio2	Fkt_dio3	Fkt_dio4
Default	2	3	4	5
Determination	always			

Fkt_dio1: (IN/OUT13)

- 0: Entry of output level via the interface (forcing)
- 1: Cooling output of controller 5
- 2: Switch over parameter set 1/2, 1 input for all controllers configured accordingly
- 6: General digital input, no processing in KS 800, evaluation via the system bus.

Fkt_dio2: (IN/OUT14)

- 0: Entry of output level via the interface (forcing)
- 1: Cooling output of controller 6
- 3: Switch off controller, 1 input for all controllers configured accordingly
- 6: General digital input, no processing in KS 800, evaluation via the system bus.

Fkt_dio3: (IN/OUT15)

- 0: Entry of output level via the interface (forcing)
- 1: Cooling output of controller 7
- 4: Leakage current monitoring input
- 6: General digital input, no processing in KS 800, evaluation via the system bus.

Fkt_dio4: (IN/OUT16)

- 0: Entry of output level via the interface (forcing)
- 1: Cooling output of controller 8
- 5: W/W2 switch-over, 1 input for all controllers configured accordingly
- 6: General digital input, no processing in KS 800, evaluation via the system bus.

23.5.2 Alarm outputs OUT17...OUT19**23.5.2.1 Action C530**

Used for configuration of the alarm output OUT17 ...OUT19 configuration (adjustable for each unit).

	C530			
Digits	4	3	2	1
Description	Mode_do17	Mode_do18	Mode_do19	
Default	1	1	1	0
Determination	always			

Mode do17: (alarm output 1: OUT17)

- 0: no alarm output
- 1: direct / normally open (default)
- 2: inverse / normally closed

Mode do18: (alarm output 2: OUT18)

- 0: no alarm output
- 1: direct / normally open (default)

Mode do19: (alarm output 3: OUT19)

- 0: no alarm output
- 1: direct/ normally open (default)
- 2: inverse / normally closed

Normally open: with alarm, the relevant output is at +24V.

Normally closed: with alarm, the relevant output is at 0V.

23.5.3 Analog outputs

In addition to the function as (analog) controller outputs, these analog outputs can output also other variables (transmitter function):

process value
set-point
correcting variable
forcing

The dead zero (0...20mA) or live zero (4...20mA) output range is determined in common for all analog outputs (in C904) and independent of use (allocation) of the individual outputs.

	C540			
Digit	4	3	2	1
Description		Mode		Src
Default	0	0	0	0
Definition	always			

Mode: (operating mode)

- 0: analog output switched off
- 1: analog output switched on
- 2: forcing switched on

Src:

- 0: process value X_{eff}
- 1: set-point W_{eff}
- 2: correcting variable Y_{pid} (2-pnt controller: 0...100%; 3-pnt controller: -100...+100%)
- 3: correcting variable HEATING of a 2/3-pnt controller Y_1
- 4: correcting variable COOLING of a 3-pnt. controller Y_2

When using the analog outputs for output of a variable mentioned in "Src", value scaling is possible.

Function block number: 80...87, type no.: 113, function number 0.

Code	Description	R/W	Type	Description	Range	Default	
	31	Force value	R/W	FP	Forcing value	0...100	0
B3	71	Xo	L/S	FP	Phys. value at 0%	-999...9999	0
	72	X100	L/S	FP	Phys. value at 100%	-999...9999	0
	73	C540	L/S	INT	Mode:Mode (H) Src: signal source (E)	0...0y0z	0

23.5.3.1 C600, C602, C603, C604 type of alarms

In C600, C602, C603 and C604, the alarm type is configured (adjustable individually for each controller).

With common alarm configuration selected in C904, there is only C600, which is valid for all alarms. With separate alarm configuration selected in C904, the allocation is:

- C600 = low low alarm
- C602 = low alarm
- C603 = high alarm
- C604 = high high alarm

As 4 independent alarms exist in this configuration, each one also requires an own fail alarm.

	C600, C601, C603, C604			
Digit	4	3	2	1
Description	Ver	Src	Fnc	DestFail
Default setting	0	2	0	0
Definition	always			

Ver:

- 0: common sources (old version)
- 1: different sources (new version)

Src: (alarm signal source)

- 00: no source alarms switched off
- 01: Xeff absolute limit contact
- 02: Xw relative limit contact
- 03: Weff absolute limit contact
- 04: Ypid absolute limit contact

Fnc: (alarm function)

- 0: no alarm alarm switched off
- 1: sensor fail
- 2: sensor fail or measured value alarm
- 3: sensor fail or measured value alarm with suppression with set-point changing, or start-up
- 4: measured value alarm
- 5: measured value alarm with suppression when the set-point changes, or with start-up

DestFail: (fail alarm target)

- 0: no output
- 1: output on OUT17
- 2: output on OUT18
- 3: output on OUT19

23.5.3.2 C601 alarm target

In C601, the target for output of a trigger point to the output is configured (adjustable for each controller).

	C601			
Digits	4	3	2	1
Description	DestLL	DestL	DestH	DestHH
Default	0	0	0	0
Determination	always	always	always	always

DestLL: (target of LL-trigger point)

- 0: no output
- 1: output to OUT17
- 2: output to OUT18
- 3: output to OUT19

DestL: (target of L-trigger point)

- 0: no output
- 1: output to OUT17
- 2: output to OUT18
- 3: output to OUT19

DestHH: (target of HH-trigger point)

- 0: no output
- 1: output to OUT17
- 2: output to OUT18
- 3: output to OUT19

DestH: (target of H-trigger point)

- 0: no output
- 1: output to OUT17
- 2: output to OUT18
- 3: output to OUT19

Note concerning the trigger point description:

LL and HH describe the low low and high high alarm trigger points, L and H describe the low and high alarm trigger points.

Example for a relative limit contact

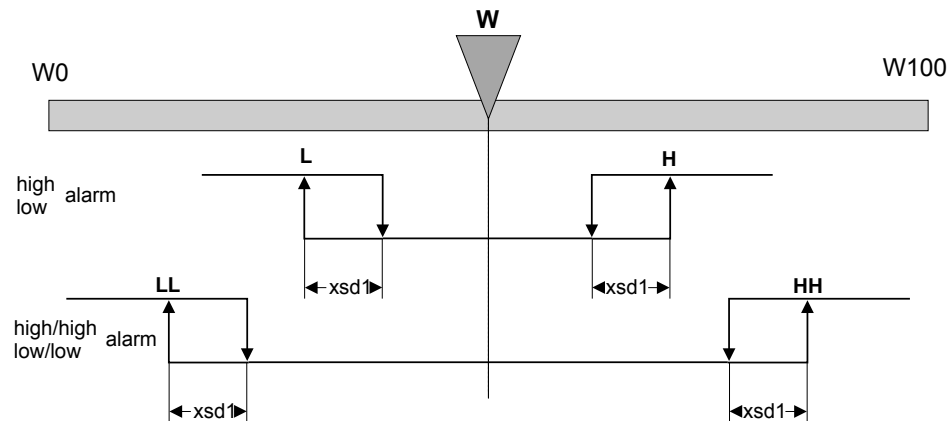

23.5.4 C700 controller self-tuning

For adjustment of the type of controller self-tuning and type of controlled adaptation (adjustable for each unit).

	C700			
Digits	4	3	2	1
Description	OMode	OCond	OGrp	OCntr
Default	0	0	0	0
Determination				

OMode: (controller self-tuning)

0: based on the calculated process characteristics T_u and V_{max} .

OCond: (process at rest mode)

0: $\text{grad}(x) = 0$ process at rest is detected, when x is constant

1: $\text{grad}(x) \leq 0 = \text{const.}$ & inverse: process at rest is detected, when x decreases evenly with a controller with inverse action.

$\text{grad}(x) \geq 0 = \text{const.}$ & direct: process at rest is detected, when x increases evenly with a controller with direct action.

2: $\text{grad} \neq 0$ process at rest is detected, when x changes evenly. In this case, continuation of this constant change over the duration of identification must be ensured.

OGrp: (determination of group self-tuning)

0: no group self-tuning (only individual optimization possible)

1: group self-tuning

OCntr: (controlled adaptation mode)

0: no function

2: switch-over only via the interface

3: switch-over via interface or control input

23.5.5 Additional functions

23.5.5.1 C900 Baud rate COM1 PC interface

The Baud rate of the serial interface COM1, (PC interface, Western socket) is configured (adjustable for each unit).

Important This interface is a pure "point-to-point-connection", i.e. addressing is not necessary. **Unless there are no other important reasons, the default setting of this function should remain unchanged.**

	C900			
Digits	4	3	2	1
Description	Baud			
Default	0	04		0
Determination	always			

Baud: (Baud rate)

- 01: 2400 Bd
- 02: 4800 Bd
- 03: 9600 Bd
- 04: 19200 Bd

23.5.5.2 C901 COM1 address

The address for COM1 is adjusted in C901.

	C901			
Digits	4	3	2	1
Description	Adr			
Default	0			
Determination	always			

Adr: (interface address)

0 ... 99

Note: Preset address "0" should not be changed. As this interface provides a "point-to-point connection", address changing is not purposefull. If this address is changed into an unknown address, building up the communication between PC and KS 800 again is very difficult.

23.5.6 COM2 interface

Address and Baudrate for the COM2-interface can be adjusted for each KS 800 via hardware or software.

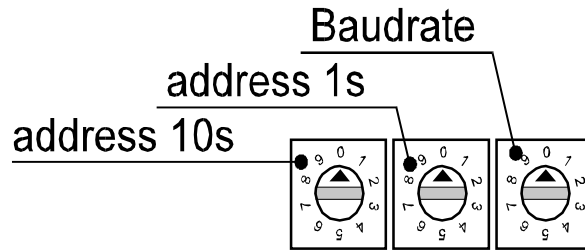

Hardware **address** adjustment is possible within "01" and "99". In position "00", the address stored in EEPROM is taken over during switch-on and can be changed via software. The address adjusted by switch position has priority and cannot be changed via software. The same applies to the **Baudrate**: in position "0", the Baudrate from the EEPROM is effective initially and can be changed via software. The digits on the switch correspond to the values used for Baudrate determination during configuration in C902.

Switch position	RS485	CANopen	DeviceNet *)
0	from EEPROM	from EEPROM	from EEPROM
1	2400 Bd	20 kBd	invalid
2	4800 Bd	125 kBd *)	125 kBd
3	9600 Bd	500 kBd *)	500 kBd
4	19200 Bd	1MBd	invalid
5	invalid	10 kBd	invalid
6	invalid	50 kBd	invalid
7	invalid	250 kBd *)	250 kBd
8	invalid	800 kBd	invalid
9	invalid	default	invalid

Baudrate setting for the PROFIBUS DP version is automatic and therefore not necessary.

*) Only these Baudrates are available for DeviceNet. With faulty switch position 125 kBd is set automatically.

23.5.6.1 C902 Baud rate COM2 bus interface

The Baudrate of the serial interface COM2 (bus interface, sub-D connector) is configured in this configuration word (individually adjustable for each instrument). The Baudrate must be identical with master (PLC, operating unit) and KS800, otherwise, no communication is possible.

Note: There can be masters with firmly adjusted Baudrate (BT800=500kBd).

C902				
Digits	4	3	2	1
Description	Baud			
Default	0	RS=03; CAN=01; Profi=automatic		0
Determination	always			

Baud rate selection:

Selected	KS 800-RS	KS 800-CAN	KS 800-Profi
01	2400 Bd	20 kBd	Automatically selected.
02	4800 Bd	125 kBd *)	
03	9600 Bd	500 kBd *)	
04	19200 Bd	1 MBd	
05	invalid setting	10 kBd	
06	invalid setting	50 kBd	
07	invalid setting	250 kBd *)	
08	invalid setting	800 kBd	

*) Only these Baudrates are available for DeviceNet. With faulty switch position 125 kBd is set automatically.

23.5.6.2 C903 COM2 address

The address for COM2 is adjusted in C903.

C903				
Digits	4	3	2	1
Description	Adr			
Default	RS=0; CAN=1; Profi=126			
Determination	always			

Adr: (interface address)

KS800-RS	KS800-CAN	KS800-Profi	KS800-DN
ISO1745	CANopen	Profibus	DeviceNet
0 ... 99	1 ... 127	0 ... 126	1 ... 63

23.5.7 C904 mains frequency, alarm and current output configuration

For optimum suppression of mains frequency interference, the mains frequency can be configured in **Frq** .

From operating version 5 and instrument number 8385 (January 2002) configuration of the four limit values for each controller channel is possible individually on **Alm-Ver** : alarm source, function and error output. Bit Alm-Ver permits distinction of the above criteria. For older instruments, the Alm-Ver bit must be always zero. Newer instruments can be configured according to the old or new method. (Old, common method means that there is only one common configuration for all alarms; with the new, separate method, the alarm configuration is adjustable individually for each of the 8 controllers.)

When using the separate alarm version, the configuration is:

- C 600 low low alarm
- C 602 low alarm
- C 603 high alarm
- C 604 high high alarm

These configuration words are identical as to their structure.

	C904			
Digit	4	3	2	1
Description	Frq	Alm-Ver	Mode-aout	Mode-out
Default	0	0	0	0
Definition	always			

Frq: (mains frequency)
0: 50 Hz
1: 60 Hz

Alm-Ver: (alarm version)
0: common alarm configuration (old)
1: separate alarm configuration (new)

Mode-aout: (configuration of analog outputs)
0: automatic configuration of the analog output order (old)
1: manual configuration of the analog output order (new)

Mode_out: (current zero)
0: 0...20mA
1: 4...20mA

Annex

24 Special functions

For some users, KS 800 was equipped with special functions according to the user specifications. These functions are not of general interest and need not be taken into account by the normal user.

24.1 Selective mean value formation

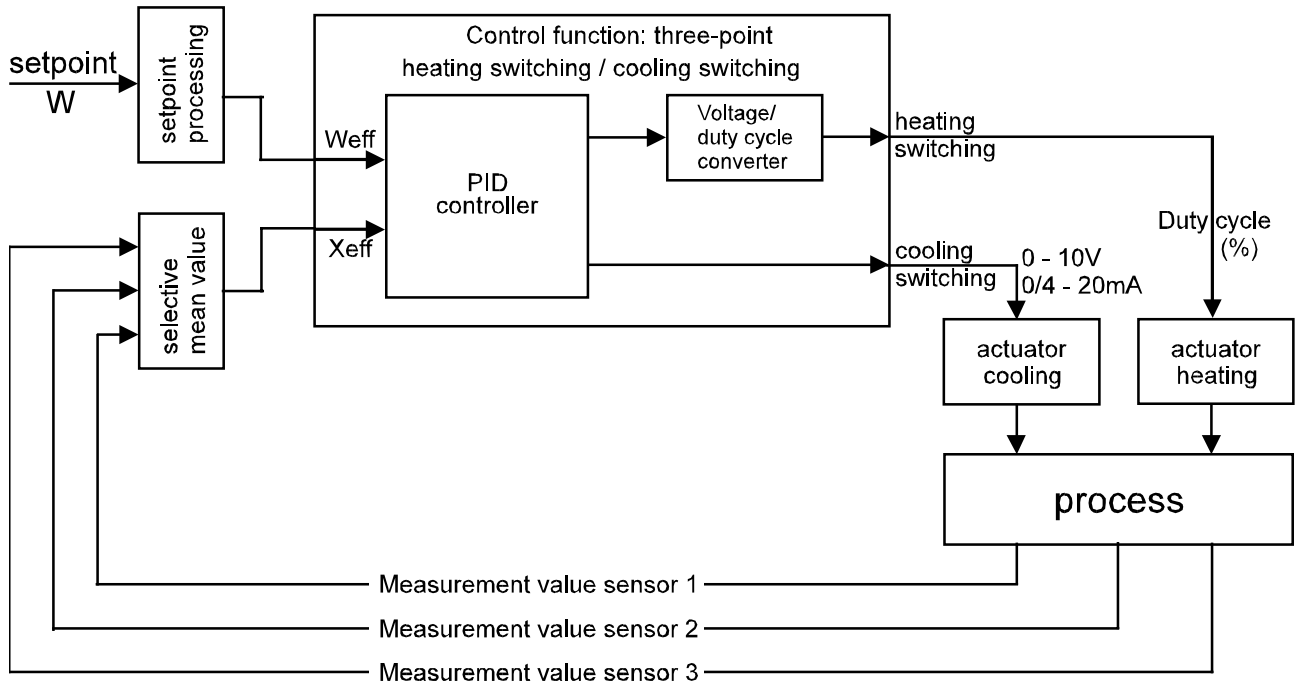

Blockdiagram for selective mean value

Mean value formation of one, two or three measured values is possible. For mean value formation, the measurement value of the concerned controller and of the following or of the two following controllers is always used.

		Mean value of 2 controllers		
		Mean value of 3 controllers		
controller 1	used for mean value formation	measurement 1	measurement 2	measurement 3
controller 2		measurement 2	measurement 3	measurement 4
controller 3		measurement 3	measurement 4	measurement 5
controller 4		measurement 4	measurement 5	measurement 6
controller 5		measurement 5	measurement 6	measurement 7
controller 6		measurement 6	measurement 7	measurement 8
controller 7		measurement 7	measurement 8	measurement 1
controller 8		measurement 8	measurement 1	measurement 2

The effective process variable is calculated using the following formulas: (R = controller number)

$$X_{\text{eff}}(R) = \frac{X(R) + X(R+1) + X(R+2)}{3}$$

mean value formation of 3 measurements

$$X_{\text{eff}}(R) = \frac{X(R) + X(R+1)}{2}$$

mean value formation of 2 measurements

$$X_{\text{eff}}(R) = X(R)$$

no mean value formation

If individual measurement signals are disturbed with "selective mean value" control (sensor break), mean value formation for the disturbed measurements is omitted. In this case, calculation is only for the correctly operating measurements.

If all concerned measurements are disturbed, control goes into the fail condition. The controller behaviour is as determined by configuration (CFail = c101, digit 2). The actual measurement value of controller 1 (upscale/downscale/substitute value) is displayed as effective measurement value.

The individual measurement values can be provided with a tolerance band. The values are specified in Liml (low limit value) and Limh ((high limit value). A measured value which is lower than the lowest value of this band or higher than the highest value of this band is not used for mean value formation any more. Mean value formation is only over measurements which work correctly. With failure of two measurement values, only the remaining value is used for control.

With the alarm limits switched off, the measurements are treated as if the range was not exceeded, i.e. mean value formation is always provided.

KS 800 does not recognize settings which do not make sense, e.g. two adjacent controllers are mean value controllers. These preclusions must be taken into account by the programmer.

The controller output is the controller with the lowest number of a group.

The two other controller outputs cannot be used (control loop interruption). These "controllers" can still be used as positioning output or for evaluation of process value alarms.

24.1.1 Configuration

This special function is activated in configuration word C100. Mean value formation is determined in digit 2.

(For better clarity, the overall configuration word C100 is described again below.)

	C100			
Digit	4	3	2	1
Description	CFunc			Wfunc
Default	02		0	0
Determination	always			

CFunc: (Controller Function, control behaviour)

- 00: Signaller 1 output
- 01: Signaller 2 outputs
- 02: 2-point contr. (or master controller with output Ypid slave contr. setpoint)
- 03: 3-point controller (heating switching / cooling switching)
- 04: 3-point controller (heating continuous / cooling switching)
- 05: 3-point controller (heating switching and cooling continuous)
- 07: 3-point stepping controller
- 10: Continuous controller
- 11: Split-range controller heating continuous / cooling continuous)
- 12: 3-point controller water-cooling
- 13: Limiter with holding function

CType: (Contr. type) special function, normally not required

- 0: Standard control (no mean value formation)
- 4: Mean value with the (one) next higher number
- 5: Mean value with the two controllers with the next higher values

Wfunc: (set-point function)

- 0: Set-point $W_{\text{eff}} = W_{\text{int}}/W_2$
- 1: Set-point/cascade $W_{\text{eff}} = W_{\text{int}}/W_{\text{ext}}$ (with slave controller: $W_{\text{ext}} = Y$ from master controller)

24.2 Safety limiter with holding function

Each one of the 8 KS 800 controllers can be used as a safety limiter with holding function. If this alarm contact has responded once, it does not return to the "good condition" automatically. For de-activating the alarm, 2 conditions must be met:

1. The process value must be lower than the set-point with hysteresis Xsd1.
2. Disabling must be released, which is done with signal Coff either via the bus (can be controlled individually for each channel), or in common via digital input Coff (In/Out14) for all channels configured accordingly.

Enabling via the interface is done with the rising signal edge. Enabling is acknowledged by KS 800 by resetting signal Coff to "0".

If the enable signal is provided via the digital input, it is effective as long as signal "1" is applied to the input. For re-activating the disabling function, the signal at IN/OUT14 must be set to "0".

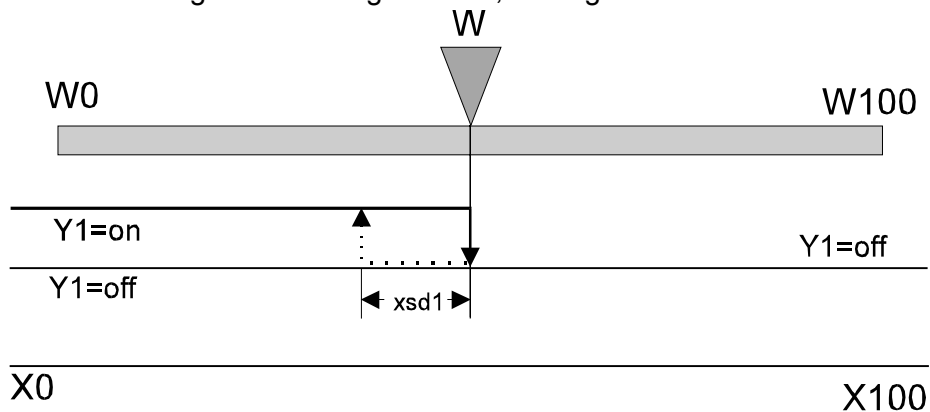

Safety limiter with releasable holding function

Output resetting (... line) is possible only after releasing

Behaviour with sensor error

If one of the KS 800 controllers is configured as a safety limiter with holding function, the relevant output is switched off completely in case of sensor error (break / wrong polarity). For re-activating the output, the sensor error must be removed and enabling via Coff like with normal exceeding of set-point must occur.

